

Sequencer TFC 8 8 Output Channels



Use and Maintenance Instructions

Description	3
Electrical Specifications	4
Dimensions and Constrains	5
Warning symbols used in this manual	6
Installation regulations and warnings	6
Electrical wirings	8
Terminals Table	9
Recommended cable cross-section	10
Fuse Table & replacing	10
Jumper Configuration for Power Supply Input	11
Jumper Configuration for Output Voltage	11
Display and pushbuttons	12
Accessing the programming menu	12
List of Parameters	13
Description of the operations	14
Operating Modes	15
Other functions	15
Hour Counters	16
Inputs & Outputs	17
Hidden Parameters	18
List of Hidden Parameters	19
Main functions of the Hidden menu	21
Alarms	22
Troubleshooting	23
Maintenance	24
Disposal	24
Warranty	24
Warranty Exclusions	24

Description

The TFC 8 control unit is an electronic device designed to drive pneumatic cleaning of industrial dust collector systems.

The construction technology of the TFC 8 allows to connect up to 8 solenoids valves.

The control unit is equipped with a powerful microcontroller that, thanks to an innovative software, makes the instrument easy to use even by inexperienced users.

The TFC 8 control unit is equipped with a seven segment display, through which the user can monitor the entire cleaning process and make the settings by means of a series of buttons placed on the front panel of the device.

Main features:

- 2 digital free-voltage contact inputs for remote control (Remote Enable & Fan Status);
- 2 Alarm relays (event programmable);
- 8 outputs for solenoid valve actuators;

Other features:

- 7 segment 3 digits 0,8" LED display;
- Power supply selectable in hardware for 115-230Vac 50/60Hz or 24Vac-24Vdc;
- Output voltage selectable in hardware and software for 24Vdc, 24Vac, 115Vac, 230Vac;
- Fully configurable cleaning cycle;
- Post cleaning function (PCC) when Fan is OFF, by detection on the "Fan Status" contact input;
- Total and partial hours counter for maintenance;
- Alarm for solenoid valve not operating;
- Alarm for maintenance of filter elements;
- Remote enabling of the Control unit by mean of "Remote Enable" contact input;
- Single solenoid actuator manual activation for system check;

Electrical Specifications

Power Supply Voltage		115Vac 50/60 Hz ± 10 % 230Vac 50/60 Hz ± 10 % 24Vac 50/60 Hz ± 10 % (on request) 24Vdc ± 10 % (on request)
Power consumption		28 VA @ max Load (on request: 50VA)
Protection fuse		1AT (115Vac - 230Vac models) 3AT (24Vac / 24Vdc models)
Operating Temperature		-10°C ÷ 55°C
Storage Temperature		-20°C ÷ 60°C
Environmental Humidity		0 ÷ 95% Relative (Non Condensing)
Solenoid valve opening Pulse Time		50msec ÷ 9,99sec
Pause Time between solenoid solenoids activations		1sec ÷ 999sec
Output Voltage For Solenoid solenoids		115Vac 50/60 Hz 230Vac 50/60 Hz 24Vac 50/60 Hz 24Vdc
Digital inputs (Not galvanically isolated free-voltage input)		1x FAN OFF detection 1x REMOTE Enable
Digital outputs (free-voltage contacts)		2x SPST FORM A Relay contact
Display		3 digit 0,8" 7 segments LED display
Casing		Base = ABS Transparent cover = Polycarbonate
Protection Degree From Water And Dust		IP65 DIN EN 60529
Shock Resistance		IK08 (EN62262).
Weight		2,1 Kg

Dimensions and Constrains

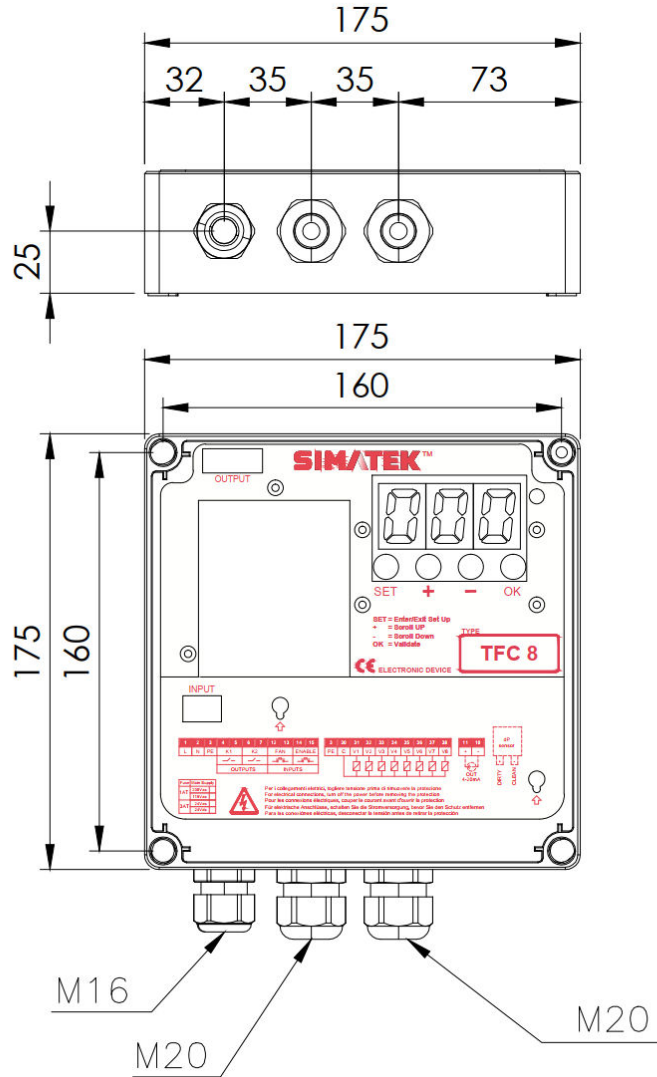

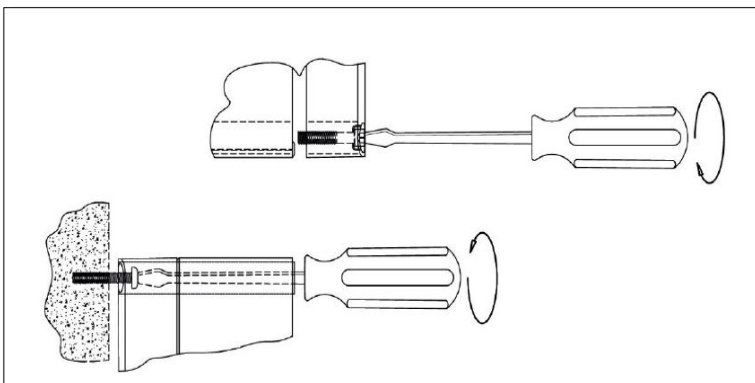

Dimensions in mm

Fastening









Warning symbols used in this manual

The safety-related indications are highlighted using the symbols:

	Attention - Danger	Warning - Generic
	Risk – Danger	Electric Current
	Dispose of in compliance with the electrical and electronic equipment Standard WEEE	

Installation regulations and warnings

<ul style="list-style-type: none"> Protect the equipment from direct exposure to sunlight. 	
<ul style="list-style-type: none"> Do not position the equipment near or directly in contact with sources of heat or electromagnetic fields. 	
<ul style="list-style-type: none"> Fix the Control Unit at a height of at least 60 cm from the ground floor and in a clearly visible place that is easily accessible. 	
<ul style="list-style-type: none"> Connect the Control Unit to a power supply line other than those used for operating motors or other high power devices, which could generate network interference or instability. 	
<ul style="list-style-type: none"> The power supply must be protected by a 230Vac 30mA Residual Current Device RCD and a bipolar 230Vac 10A magnet circuit breaker, positioned in a place that is easily accessible. 	
<ul style="list-style-type: none"> Before intervening on the equipment to perform any operation, deactivate the magnet circuit breaker switch and check if the environment conditions are safe. 	
<ul style="list-style-type: none"> For electric operations, always remove voltage, wait 30 seconds for the internal capacitors to discharge before opening. At the end of the operations, close the equipment before powering up. Before intervening on the equipment to perform any operation, check the conditions of the atmosphere are safe. 	
<ul style="list-style-type: none"> The PE (ground terminal/Earth) wire must be Yellow/Green and it must be the first to be connected. No other cables different than PE must be with its color. 	
<ul style="list-style-type: none"> The terminal block must not be the mechanical anchorage point of the wires. 	
<ul style="list-style-type: none"> Sealing of the cable glands is guaranteed by the compression of the rubber gasket that tightens on the outer diameter of the cable. 	
<ul style="list-style-type: none"> The size of cable and cable gland must ensure that power cord traction is not acting on the terminal. 	

<ul style="list-style-type: none"> Any use not described in this user instruction manual or incorrect use of the device may cause damage to the Control Unit or to the equipment connected to it. 	
<ul style="list-style-type: none"> Incorrect use or tampering with the equipment may cause injury. 	
<ul style="list-style-type: none"> The impermeability of the casing is guaranteed when the cover is closed. 	
<ul style="list-style-type: none"> Make sure that rigid or flexible ducts used for wiring, do not fill up with water or other liquids. 	
<ul style="list-style-type: none"> Switch OFF the power supply immediately if water is found in the casing. 	
<ul style="list-style-type: none"> Do not make unprotected holes in the container or holes that are protected by accessories with protection rating lower than that of the Control Unit. 	
<ul style="list-style-type: none"> If the Control Unit is used in ways not specified by the manufacturer, the protection provided by the device may be impaired. 	
<ul style="list-style-type: none"> No part with dangerous voltage is normally accessible. 	
<ul style="list-style-type: none"> The Control Unit does not release potentially toxic or harmful substances to the health and the environment. 	

	<u>IMPORTANT</u>
Do not use the control unit if you have not read or do not understand this manual.	

Electrical wirings

To connect the wires to the Control Unit, remove the lower front panel to access the terminal board, unscrewing the two screws.

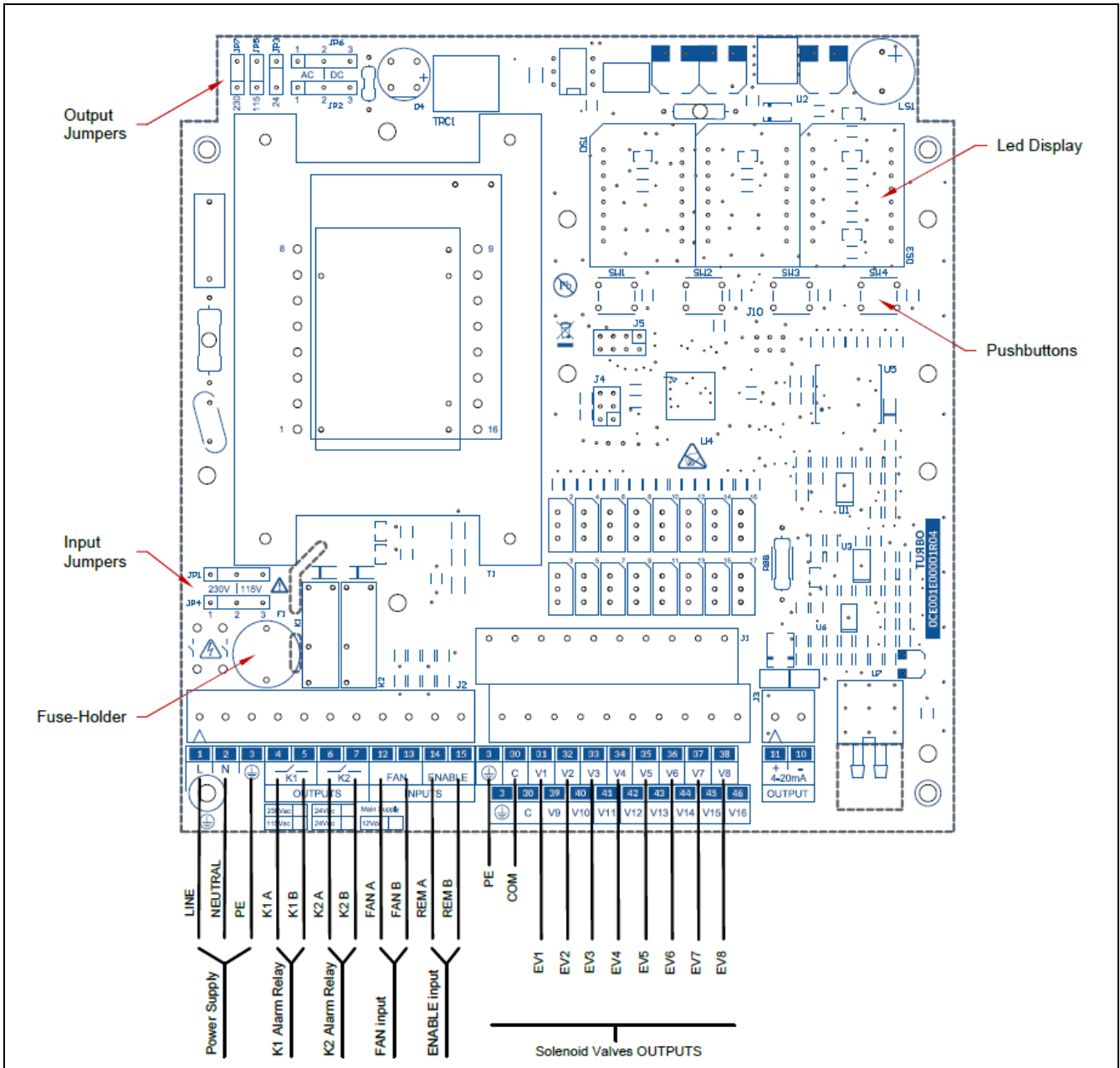

Note: If the Control Unit is a +24Vdc power-supplied model, please connect:

Terminal 1	=	+24Vdc IN
Terminal 2	=	0Vdc IN
Terminal 3	=	PE

Terminals Table

Ref.	Cat	Terminal	Marking	Description	
Main Power Supply	A	1	L	115-230Vac 50/60Hz ±10%	24Vac 50/60Hz ±10%
		2	N		24Vdc ±10%
	PE	3	PE	Protective ground terminal (Earth)	
Relay K1 Output ⁽¹⁾	B	4	1A	Contact type	1 Form A (1SPST NO)
				Ratings	250Vac/30Vdc 5A
		5	1B	Max switching voltage	400Vac
				Dielectric Strength	4000Vac (750Vac contacts)
				Expected life	10M mechanical, 100K electrical
Relay K2 Output ⁽¹⁾	B	6	2A	Contact type	1 Form A (1SPST NO)
				Ratings	250Vac/30Vdc 5A
		7	2B	Max switching voltage	400Vac
				Dielectric Strength	4000Vac (750Vac contacts)
				Expected life	10M mechanical, 100K electrical
Fan Status Input ⁽²⁾	C	12	FANA	Mode	Free contact (limited to 5mA@5V)
			13	FANB	Insulation
Remote Enable Input ⁽²⁾	C	14	REMA	Mode	Free contact (limited to 5mA@5V)
			15	REMB	Insulation
Ground	PE	3	PE	Protective ground terminal (Earth)	
Solenoid Valve Common	D	30	COM	Ratings	8A
				Max switching voltage	600VAC
Solenoid Valve Output	D	31	EV1	Ratings	4A
				Max switching voltage	600VAC
		32	EV2		
		33	EV3		
		34	EV4		
		35	EV5		
		36	EV6		
		37	EV7		
		38	EV8		

Note (1): Free-voltage SPST contacts.

Note (2): Free-voltage contacts powered by the main-board. DO NOT provide voltages at these terminals.



DANGER

Risk of electric shock

The input and output terminals, numbered 12 to 15 are safety extra low voltage (SELV) terminals and must only be connected to low voltage circuits.

Recommended cable cross-section

Cat	Cable Cross-section	Approvals	Notes
A	0,75 mm ²	IEC60227, IEC60245	No-Flame or flame-retardant cable
B	0,75 mm ²	IEC60227, IEC60245	No-Flame or flame-retardant cable
C	0,50 mm ²	IEC60227, IEC60245	No-Flame or flame-retardant cable
D	0,75 mm ²	IEC60227, IEC60245	No-Flame or flame-retardant cable
PE	0,75 mm ²	IEC60227, IEC60245	No-Flame or flame-retardant cable, Yellow/Green cable

Fuse Table & replacing

Voltage	Value
230 Vac	1AT 250V
115 Vac	1AT 250V
24Vac/dc	3AT 60V/250V



DANGER

Risk of electric shock

Before replacing the main Fuse on the board, you **MUST** remove the main power supply to avoid electrical shocks.

To replace the fuse:

- Remove the lower front panel;
- Unscrew the black fuse-holder cap;
- Remove the fuse cap with the fuse inside;
- Replace the fuse with a new one;
- Insert the fuse in the fuse cap;
- Insert the fuse cap into the fuse-holder;
- Screw the fuse-holder cap;
- Close the lower front panel;
- Power-on the Control Unit.

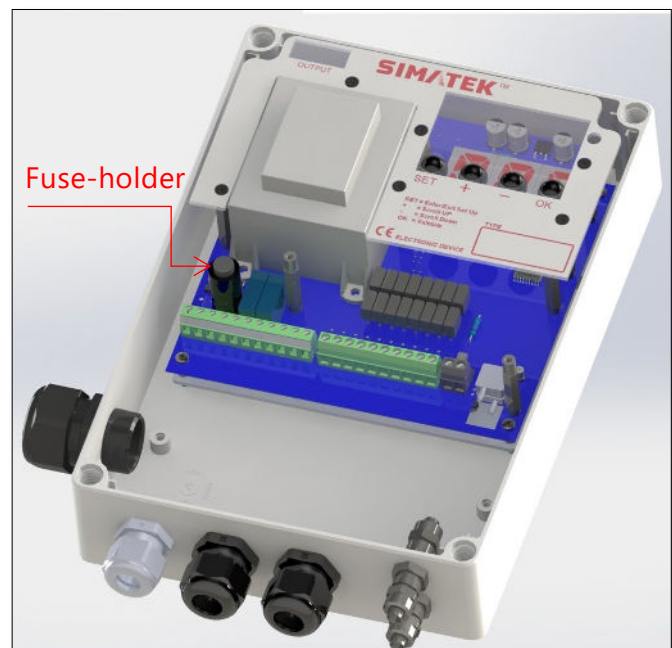

Jumper Configuration for Power Supply Input

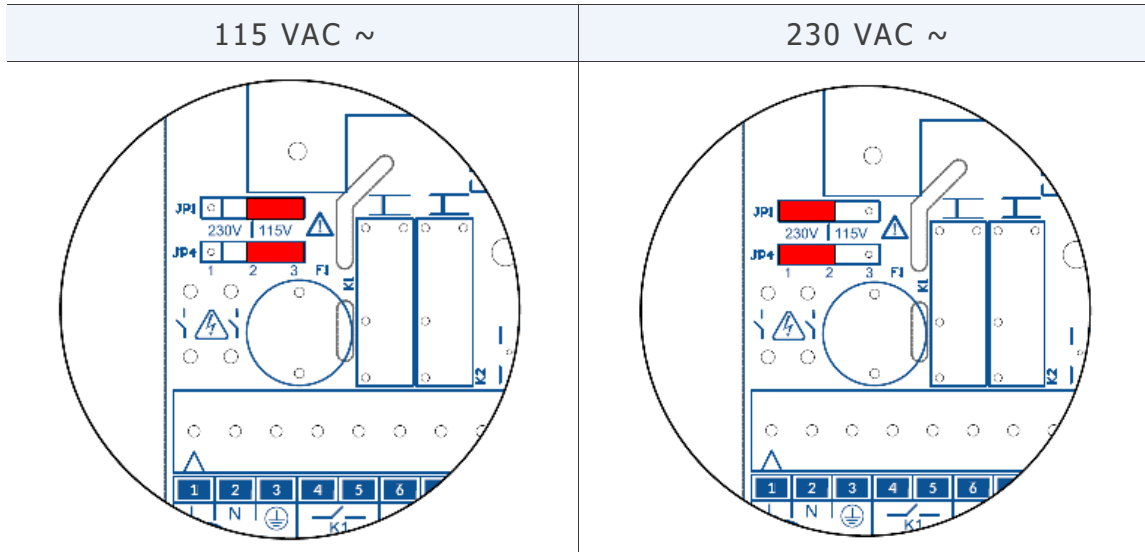

In the 24Vac and 24Vdc models JP1 and JP4 jumper are not used.

Jumper Configuration for Output Voltage

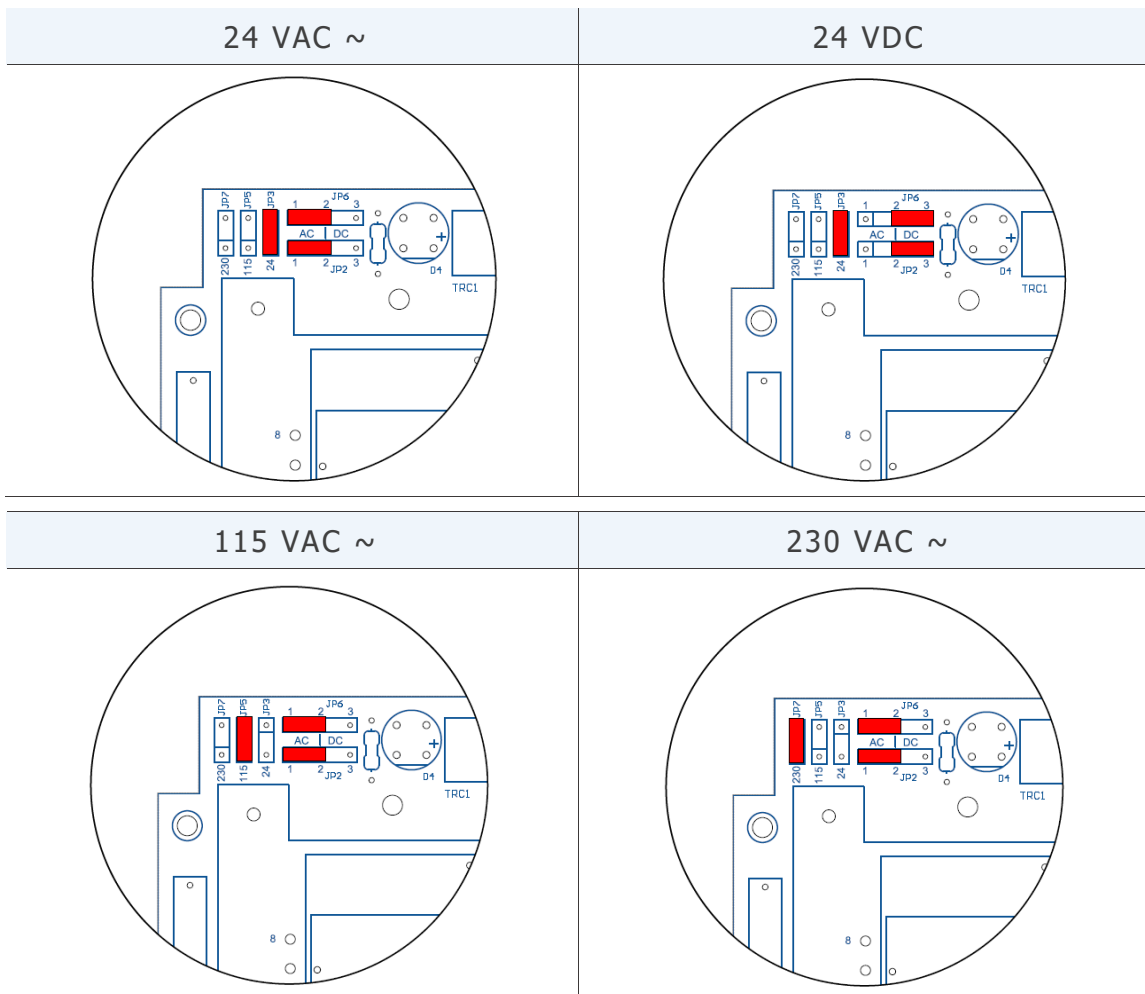

The output voltages 115Vac or 230Vac is not available in 24VAC or 24VDC power input models,

Display and pushbuttons

A local user interface made of a large seven segment display and four pushbuttons is available on the Control Unit. The user interface shows the main functionalities and events during a cleaning process.

It is also useful to access to the programming parameters.

At power-on the Control Unit will show the software version mounted for few seconds and then it will be ready to be used.

The Pause Time countdown is the main information shown on display. It will be alternated with some other information like output pulsed and error codes.

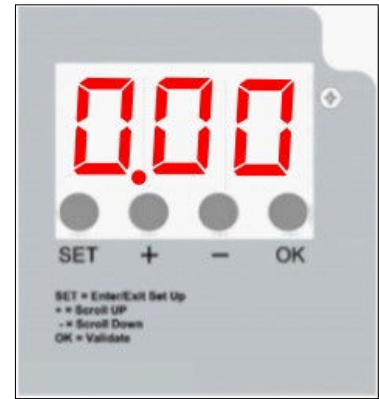

The pushbuttons enable the user to perform some operations:

(SET)	Enable the user to access or exit the programming mode.
	Activate a single solenoid during manual test with the related function F06, available in programming mode.
(OK)	Save parameter's value modified during programming mode.
	Reset alarms in main screen.
(+)	Increases the scroll of the parameters in programming mode.
	Increases the value of a selected parameter during programming.
	Displays the total hours counter since the first power-on.
(-)	Decreases the scroll of the parameters in programming mode.
	Decreases the value of a selected parameter during programming.
	Displays the partial hours counter for maintenance.

Accessing the programming menu

Press (SET) pushbutton to access the programming mode. The blinking message "F02" will appear to indicate the first parameter available.

Press (+) or (-) pushbuttons to move at the required parameter.

Press (OK) pushbutton to access the value of the selected parameter.

Press (+) or (-) pushbuttons to change the value of the parameter.

Press (OK) to save the parameter's value.

Press (SET) pushbutton to exit the programming menu and return to the main screen.



List of Parameters

Function	Min Value	Max Value	default Value	
F02 Solenoid activation Time (seconds)	0,05	5,00	0,20	
F03 Pause Time between solenoids activations (seconds)	001 010 (F01=3)	999	20	
F04 Number of solenoids connected	01	08	01	
F05 Output voltage setting (related to hardware jumpers)	D24= Out 24Vdc A24= Out 24Vac 115= Out 115Vac 230= Out 230Vac	d24	230	A24
F06 Manual Solenoid valve activation for test	1	F04	1	
F13 Amount of Post Cleaning cycles after Fan stop	0	99	1	
F14 Pause Time between solenoids valve activation when in Post Cleaning cycle (seconds)	1	999	10	
F15 Maintenance Time limit for warning (E11) expressed in 10th of hours	1	999	100	
F16 Maintenance Time limit warning (E11)	0=Disabled 1=Enabled	0	1	0
F17 Maintenance Hour counter Reset	0=No Reset 1=Reset Counter	0	1	0
F24 Exclusion of a solenoid in case of short circuit	0=Leave the solenoid 1=Skip the solenoid	0	1	0

Notes:

Description of the operations

After showing the software version at power-on, the Control Unit shows the message “---”, meaning that a diagnostic task is running to check the coherence between settings stored in the microcontroller memory and the hardware jumpers settings.

An error code will appear in case of discrepancies between settings (see Alarms list). Only editing functions will be allowed on the Control Unit. The operator may switch-off the device, check and configure the hardware jumpers in the right manner.

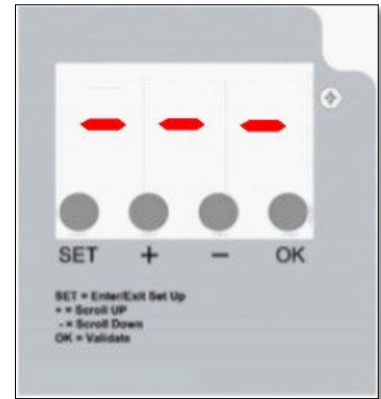

At the end of the diagnostic task, a “0_0” message will appear on the display to indicate that the test was successfully completed.

The Pause Time countdown will appear on the main screen.

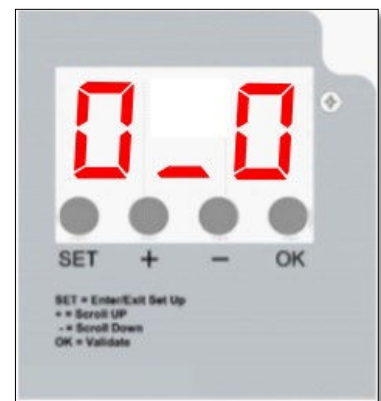

A “OFF” message appears if the “Remote EN” contact input (terminals 14-15) is open.

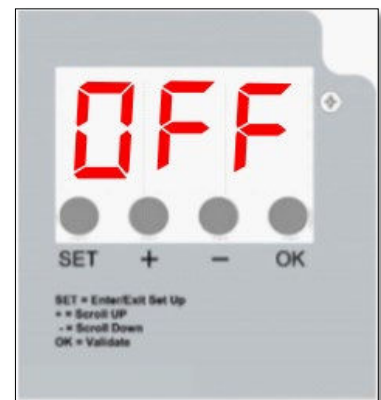

A “-0-” message appears if the “FAN Status” contact input (terminals 12-13) is open when the Control Unit is in Manual mode.

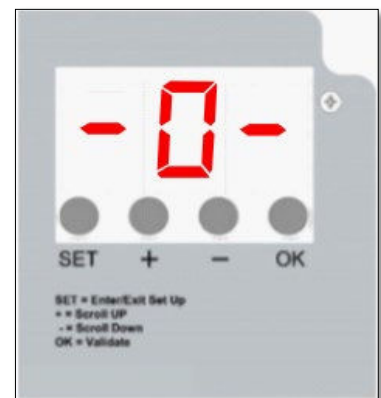

Operating Modes

MANUAL Mode

The Control Unit works as a programmable cycle sequencer.

The solenoids connected at the control unit will be activated sequentially in order to perform a cleaning cycle, with the timing values configured in the related parameters. After the last activated solenoid valve, the cleaning cycle will continue restarting from the first solenoid valve.

Parameters involved:

F01	0 (MANUAL)
F02	Pulse Time
F03	Pause Time

Other functions

POST CLEANING CYCLE (PCC)

This function allows to perform a cleaning cycle after the fan was stopped (OFF state) by the user.

The PCC function is enabled if the value configured in "PCC cleaning cycles" was set with a value different from zero. This parameter determines how many PCC cycles will be performed.

If "Fan detection mode" parameter is set to 0, the PCC function will be performed only if the Fan Status Input contact (terminals 12-13) will be opened.

The PCC Pause Time is available to be set in order to perform a different Pause Time than in standard cleaning cycle. The Pulse Time (F02) is the same previously set for a standard cleaning cycle.

Parameters involved:

F13	PCC cleaning cycles
F14	PCC Pause Time
F53	Cycle END mode
F64	Enable cleaning cycle

PCC handled by "FAN OFF" input contact

The number of the PCC to perform can be set with "PCC cleaning cycles" parameter. At the end of the last PCC, the Control Unit will stop all activities until the Fan Status Input contact will be detected as closed. Then, a new standard cleaning can start, if required.

If the Fan Input Contact is detected as closed while a PCC is in progress, a new standard cleaning cycle will be started at the end of PCC, if required.

Only PCC cleaning cycle

It is possible to set "Enable cleaning cycle" parameter to zero in order to perform only PCC function, disabling all the other cleaning modes. In this way the only cleaning cycle available will be a PCC and it will be performed only if the FAN OFF state will be recognized by contact.

Number of solenoids connected

The amount of solenoids valves connected at the Control Unit can be set. The Control Unit will run the cleaning cycle in order from the first to the last solenoid valve programmed into the parameter.

Parameters involved:

F04	Number of solenoids
-----	---------------------

Hour Counters

After showing the software version at power-on, the Control Unit

An hour counters information is available on the main screen.

The purpose is to show the total operating hours from the first power-on and the maintenance hours.

By pressing the (+) pushbutton the display will show the operating hours from the first power-on. The value can't be reset.

By pressing the (-) pushbutton the display will show the maintenance hours. The parameter F17 can be used to reset the maintenance hours.

The hours are shown on two screen.

The first screen shows the thousands of hours, the second screen shows the units of hours.

Example:

First screen count = 012

Second screen count = 345

Amount of hours = $(012 \times 1000) + 345 = 12345$



Inputs & Outputs

Inputs	Terminals	Description
Remote ENABLE contact	14-15	<p>It is used to place the Control Unit in Run or Stand-By mode.</p> <p>When the input contact is open, the Control Unit is placed in stand-By mode. No functions will be executed.</p> <p>When the input contact is closed, the Control Unit is placed in Run mode. All the functions will be executed when needed.</p> <p>The Control Unit is factory set with a wire jumper between the terminals to close the input.</p>
FAN Status contact	12-13	<p>It is used to send to the control unit the state of the fan (Running or Stopped).</p> <p>If the input contact is open, the control unit will detect the fan stopped and then run the Post Cleaning function.</p> <p>The control unit is factory set with a wire jumper between the terminals to close the input.</p>

Outputs	Terminals	Description
Alarm Relay K1	4-5	<p>The relay K1 is factory configured as normally closed contact and opens with multiple error events.</p> <p>The contact is also open when the control unit is not powered.</p> <p>The alarms events set by default for the relay are: E06 E08. Maintenance interval reached.</p>
Alarm Relay K2	6-7	<p>The relay K2 is factory configured as normally closed contact and opens with multiple error events.</p> <p>The contact is also open when the control unit is not powered.</p> <p>The alarms events set by default for the relay are: E06 E08. Maintenance interval reached.</p>

Hidden Parameters

An "Hidden Parameters" menu is available on the Control Unit. With this, the expert technician can configure additional functions.

MAIN FUNCTIONS OF THE HIDDEN MENU

- Set the event to associate to Alarm Relay contact;
- Set the state of the Relay contact during alarm;
- Reset the main Hour counter;
- Set the Cycle End mode;
- Set the state of the digital inputs;
- Enable and set a delay time at power-on;
- Set Pulse Time and/or Pause Time to work in seconds or minutes;
- Reset all parameters to factory default;

HOW TO ACCESS THE HIDDEN MENU

In main screen, press (SET) and (OK) pushbuttons together for at least 2 seconds until the message "- - -" appears on the display.

Press (-) pushbutton. The message " - -" appears on the display.

Press (OK) pushbutton. The message " F50" appears on the display.

Press (+) pushbutton. The message "F50" appears on the display to confirm the access to the Hidden Menu.

In Hidden Menu:

Press (+) or (-) pushbuttons to move at the required parameter.

Press (OK) pushbutton to access the value of the selected parameter.

Press (+) or (-) pushbuttons to change the value of the parameter.

Press (OK) to save the parameter's value.

Press (SET) pushbutton to exit the programming menu and return to the main screen.

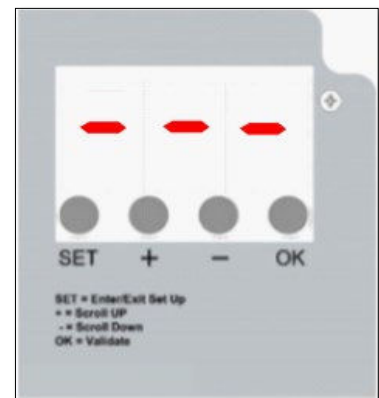

List of Hidden Parameters

Function		Min Value	Max Value	default Value
F50 Relay contact during alarm	0= OPEN with AUTORESET 1= OPEN with MEMORY 2= CLOSED with AUTORESET 3= CLOSED with MEMORY	0	3	0
<p>Note: AUTORESET = the relay contact will automatically return to its rest state if alarm event disappears. MEMORY = the relay contact will return to its rest state only if the user will press (OK) pushbutton to reset the error.</p>				
F51 Solenoid Presence and Overload	0= Disable control 1= Only Overload (E07) handled 2= Only Presence (E06) handled 3= Both Overload and Presence (E06+E07)	0	3	2
F52 Overload sensitivity (used with F51 =1 or 3)		0	9	5
F54 Main Hour Counter Reset	0= Doesn't take effect 1= Reset main hour counter	0	1	0
<u>Note:</u> After RESET, the parameter's value automatically returns to zero.				
F55 Automatic detection of solenoids	0= Disabled 1= Enabled	0	1	0
F58 Event to associate to Relay K1	0= Cumulative error ⁽¹⁾ 1= No effect 2= No effect 3= Solenoid Error (E06, E07, E08) 4= Maintenance warning 5= Cleaning cycle running 6= Control Unit powered ⁽²⁾	0	6	0
<p><u>Note</u>⁽¹⁾: Cumulative error is intended as one between E06 to E14 errors. <u>Note</u>⁽²⁾: Active closed. F50 doesn't take effect.</p>				
F59 Event to associate to Relay K2	0= Cumulative error ⁽¹⁾ 1= No effect 2= No effect 3= Solenoid error (E06, E07, E08) 4= Maintenance warning 5= Cleaning cycle running 6= Control Unit powered ⁽²⁾	0	6	1
<p><u>Note</u>⁽¹⁾: Cumulative error is intended as one between E06 to E14 errors. <u>Note</u>⁽²⁾: Active closed. F50 doesn't take effect.</p>				

Function		Min Value	Max Value	default Value
F64 Cleaning cycle	0= Only PCC cycle 1= All cleaning cycles enabled	0	1	1
F65 Jumpers test	0= Test disabled 1= Test enabled	0	1	1
<u>Note:</u> When disabled, the value of F51 is forced to zero				
F66 Shorted Output Test	0= Test disabled 1= Test enabled	0	1	1
F72 Digital Inputs setting	0= Both active closed 1= FAN STATUS active open 2= REMOTE ENABLE active open 3= Both FAN and REMOTE active open	0	3	0
F73 Unit for Pause Time	0= Seconds 1= minutes	0	1	0
F74 Delay at power-on	0= Disabled 1= Enabled	0	1	0
F75 Delay Time at power-on (minutes)		0	16	5
<u>Note:</u> used if the function is enabled by F74. Countdown in seconds.				
F76 Unit for Pulse Time	0= Seconds 1= x60 seconds (minutes) 2= x10 seconds	0	2	0
F77 Reset Parameters values to factory default	0= Disabled 1= Enabled	0	1	0
<u>Note:</u> After Reset task, the value of the parameter will automatically return to zero.				

Main functions of the Hidden menu

RELAY for event signalling

Each of the available relays can be configured to signal a well-defined event between those available.

The F50 parameter establishes how the relay contacts works during an event to handle. The parameter affect both the relay contacts at the same time and it is not possible to have a different contact setting for each relay.

If F50 is set to "0" or "2" and the related alarm event disappears, the relay will automatically return to its rest state.

If the alarm event is related to solenoids, the error will be automatically removed if the next pulse on that solenoid will be OK.

The "Control Unit powered" event is not affected by F50. When the Control Unit is powered and F58 or F59 is set to 6, the relay contact will be always closed.

Parameters involved:

F50	Relay contact during alarm
F58	Event to associate to Relay K1
F59	Event to associate to Relay K2

Solenoids Fault Events

The F51 and F52 parameters handles the error events related to solenoids. It is possible to introduce or exclude the detection of alarms concerning the missing connection of a solenoid or its overload.

It is also possible to establish the sensitivity for the overload.

F51	Solenoid Presence and Overload
F52	Overload sensitivity

State of the digital inputs

The F72 parameter handles the logic of the detection of the digital inputs.

It is possible to set the logic state of each digital inputs in order to refine the detection with the expected signal coming from an external switch, PLC or DCS device.

F72	Digital Inputs setting
-----	------------------------

Delay Time at power-on

It is possible to delay the start of control Unit functions by setting F74 and F75 parameters. The setting will take effect from the next power-on. The display will show an activation countdown expressed in seconds.

F74	Delay at power-on
F75	Delay Time at power-on

Pulse and Pause Time unit

The F73 and F76 parameters allow to change the time unit for the Pulse Time and the Pause Time. It is possible to set time unit in seconds o minutes.

F73	Unit for Pause Time
F76	Unit for Pulse Time

Reset parameters to default values

The F77 parameter allows to restore all parameters to the factory default values, with the exception of those relating to electrical and pneumatic calibrations.

F77	Reset Parameters values to factory default
-----	--

Alarms

The control Unit perform some diagnostic check at power-on and during operations.

An alarm event is shown by mean of "Exx" error code. The possible alarms and respective troubleshooting are listed in the below table:

Alarm Event	Description	Action
E01	F05 set to 24Vdc but AC jumper position detected	For 24Vdc, switch the device off and set the AC/DC jumpers to DC. For 24Vac, press OK, then press SET, set the function F05 using (+) and (-), select A24 and press OK to confirm.
E02	F05 set to 24Vac but DC jumper detected	For 24Vac, switch the device off and move the AC/DC jumpers to AC. For 24Vdc, press OK, then press SET, set the function F05 using (+) and (-), select d24 and press OK to confirm.
E03	F05 set to 24Vac or 24Vdc. Voltage Out of Range detected	To use 24V valves, switch the device off and move the output voltage selection jumper to 24V. - If the jumper is in the correct position, press OK, then SET, select the F05 function with (+) and (-), set 115 or 230 (as jumper) and press OK.
E04	F05 set to 115V. Voltage Out of Range detected	To use 115V valves, switch the device off and move the output voltage selection jumper to 115V. - If the jumper is in the correct position, press OK, then SET, select the F05 function with (+) and (-), set 115 or 230 (as jumper) and press OK.
E05	F05 set to 230V. Voltage Out of Range detected	To use 230V valves, switch the device off and move the output voltage selection jumper to 230V. If the jumper is in the correct position, press OK, then SET, select the F05 function with (+) and (-), set a24, d24 or 115 (as jumper) and press OK.
E06	Solenoid valve current lower than minimum threshold or disconnected solenoid valve. The error is displayed alternating with solenoid position Uxx failed.	Check correct connection of the solenoid valve and respective data. The alarm is auto-reset if event disappears.
E07	Solenoid valve current higher than maximum threshold. The error is displayed alternating with solenoid position Uxx failed.	Check correct connection of the solenoid valve and respective data. The alarm is auto-reset if event disappears.
E08	Short circuit alarm at output. The error is displayed alternating with solenoid position Uxx failed.	Switch the device off and back on after having checked the solenoid valve system.
E11	Maintenance deadline reached	Carry out maintenance and then reset the error.
E14	Indicates that a valve in short circuit has been excluded from the cycle. The error code E14 alternates with the indication of the failed output that is shown as "Uxx", where xx is the number of the output. An output is considered a short circuit if not responding for 3 following activations.	Switch the device off and back on after having checked the solenoid valve system.

Troubleshooting

Fault	Possible Cause	Solution
The display does not light up.	Fuse Blown. Power voltage missing.	Check the protection fuse on the power voltage. Check that the power voltage is provided at power supply terminals and compliant with that required for the device.
The outputs are not activated.	Output voltage. Wiring to solenoid valves.	Check that the solenoid valves output voltage is congruent with hardware jumper settings and programming. Check wiring between Control Unit and solenoid valves.
The cleaning cycle doesn't run	Remote Enable input is open	Check Remote Enable input contact.
Does the device occasionally reset?		Check that there are no unfiltered voltage spikes on the power line (spot welding machines, welding machines, plasma cutters etc.). Install a common-mode line filter between the Control Unit and the power line.
Does post-cleaning start during normal cleaning?	FAN OFF input is closed	Check FAN OFF
Do the alarms fail to activate relay contacts?		The relay contacts must be powered by external voltage A relay contact opens when activated by an alarm event.

Maintenance

The control unit has no parts that can be replaced, except for the fuse.

All repair operations must be carried out by the manufacturer.

To clean dust and dirt from the surfaces, gently rub with cotton or other soft cloth soaked with non-aggressive, non-abrasive detergents, use those used for glass surfaces; do not use solvents or aromatic compounds and do not rub with abrasive sponges.



Disposal

Dispose of properly after use. Dispose of the product according to laws in force for electronic equipment.

This device is for use in a dust collection system and is therefore part of a fixed installation.



Warranty

The warranty has a duration of 2 years. The company will replace any electronic component deemed defective exclusively at our workshop, except in the presence of contrary agreements to be authorized by the company.

Warranty Exclusions

The warranty will be cancelled in case of:

- Signs of unauthorized tampering or repairs.
- Incorrect use of the device not respecting technical data.
- Wrong electrical connections.
- Failure to respect system standards.
- Use not in accordance with EC standards.
- Atmospheric events (lightening, electrostatic discharges,), power surges.
- Obstructed pneumatic connections. Damaged tubes.