

Economizer TFCD 8 8 Output Channels

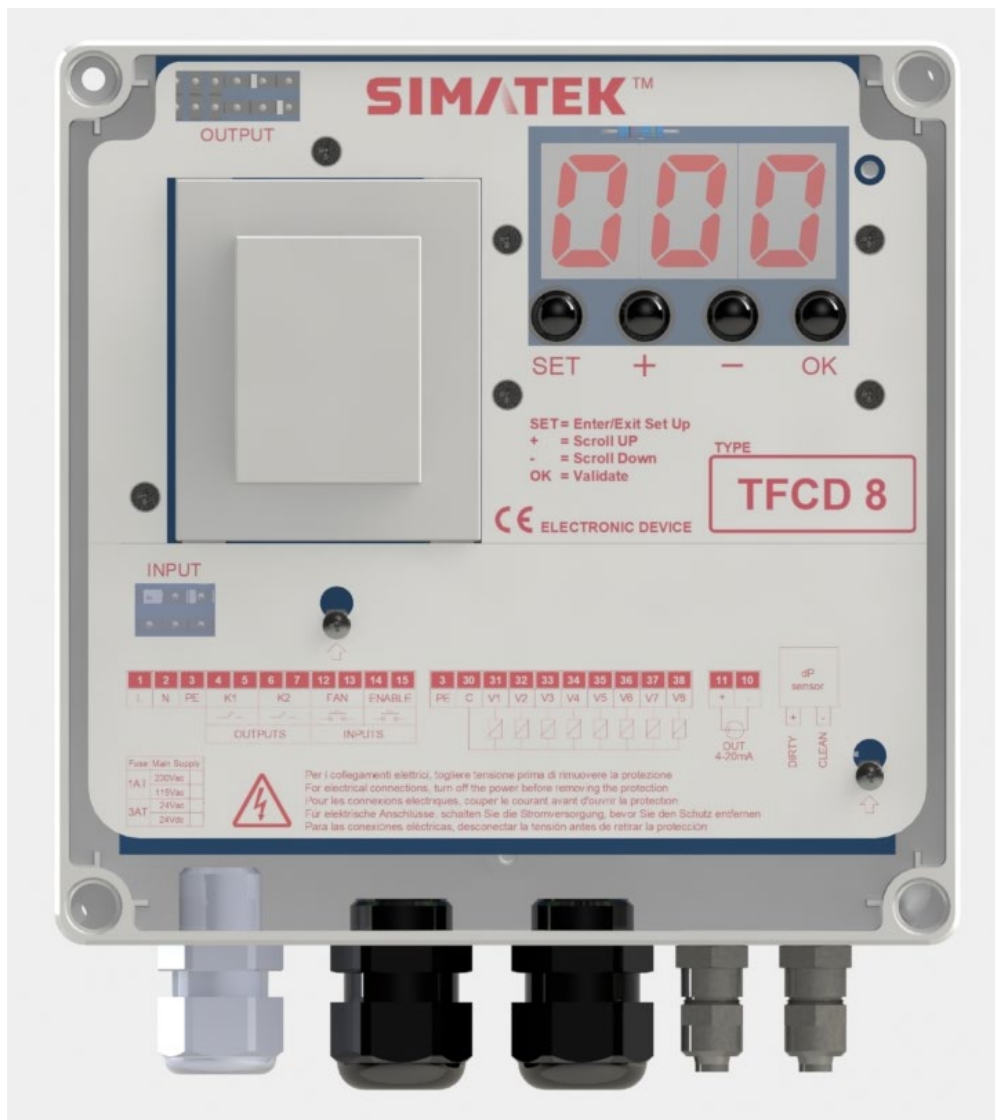

Use and Maintenance Instructions

Description	3
Electrical Specifications	4
Dimensions and Constrains	5
Warning symbols used in this manual	6
Installation regulations and warnings	6
Electrical wirings	8
Terminals Table	9
Recommended cable cross-section	10
Fuse Table & replacing	10
Jumper Configuration for Power Supply Input	11
Jumper Configuration for Output Voltage	11
Display and pushbuttons	12
Accessing the programming menu	12
List of Parameters	13
Description of the operations	15
Operating Modes	16
Other functions	18
Hour Counters	20
Inputs & Outputs	21
Hidden Parameters	22
List of Hidden Parameters	23
Main functions of the Hidden menu	26
Alarms	28
Troubleshooting	29
Maintenance	30
Disposal	30
Warranty	30
Warranty Exclusions	30

Description

The TFCD 8 control unit is an electronic device designed to drive pneumatic cleaning of industrial dust collector systems.

Thanks to the on-board digital differential pressure (dP) control, performed by the internal transducer, the TFCD 8 accurately analyzes the clogging status of the filters and automatically handles the cleaning only when necessary, thus optimizing the entire dust removal process .

The construction technology of the TFCD 8 allows to connect up to 8 solenoids valves.

The control unit is equipped with a powerful microcontroller that, thanks to an innovative software, makes the instrument easy to use even by inexperienced users.

The TFCD 8 control unit is equipped with a seven segment display, through which the user can monitor the entire cleaning process and make the settings by means of a series of buttons placed on the front panel of the device.

The TFCD 8 control unit can generate a self-powered analog 4 ÷ 20mA output proportional to dP pressure measured to send to a remote device in a control room.



Main features:

- 2 digital free-voltage contact inputs for remote control (Remote Enable & Fan Status);
- 2 Alarm relays (event programmable);
- 1 current-Loop 4 ÷ 20mA output for dP pressure transmission;
- 8 outputs for solenoid valve actuators;

Other features:

- 7 segment 3 digits 0,8" LED display;
- Operating modes selectable between "Manual", "Automatic", "Proportional" and "Forced cycle";
- Pressure measurement units in KPa;
- Power supply selectable in hardware for 115-230Vac 50/60Hz or 24Vac-24Vdc;
- Output voltage selectable in hardware and software for 24Vdc, 24Vac, 115Vac, 230Vac;
- Fully configurable cleaning cycle;
- Post cleaning function (PCC) when Fan is OFF, by setting the Fan dP threshold in the Automatic / Proportional modes or through the "Fan Status" contact input;
- Total and partial hours counter for maintenance;
- Alarm for minimum dP (broken sleeve);
- Alarm for maximum dP (clogged filter);
- Alarm for solenoid valve not operating;
- Alarm for maintenance of filter elements;
- Remote enabling of the Control unit by mean of "Remote Enable" contact input;
- Precoating function;
- Single solenoid actuator manual activation for system check;

Electrical Specifications

Power Supply Voltage		115Vac 50/60 Hz ± 10 % 230Vac 50/60 Hz ± 10 % 24Vac 50/60 Hz ± 10 % (on request) 24Vdc ± 10 % (on request)
Power consumption		28 VA @ max Load (on request: 50VA)
Protection fuse		1AT (115Vac - 230Vac models) 3AT (24Vac / 24Vdc models)
Operating Temperature		-10°C ÷ 55°C
Storage Temperature		-20°C ÷ 60°C
Environmental Humidity		0 ÷ 95% Relative (Non Condensing)
Measurable Pressure		0 - 10 kPa
Maximum Pressure Applicable		40 kPa (0.4 Bar) Higher pressures will damage the device !
Solenoid valve opening Pulse Time		50msec ÷ 9,99sec
Pause Time between solenoid solenoids activations		1sec ÷ 999sec
Output Voltage For Solenoid solenoids		115Vac 50/60 Hz 230Vac 50/60 Hz 24Vac 50/60 Hz 24Vdc
Outputs Proportionate To dP Value for Remote Pressure Reading		1x 4 ÷ 20mA current-Loop (self-powered)
Digital inputs (Not galvanically isolated free-voltage input)		1x FAN OFF detection 1x REMOTE Enable
Digital outputs (free-voltage contacts)		2x SPST FORM A Relay contact
Display		3 digit 0,8" 7 segments LED display
Casing		Base = ABS Transparent cover = Polycarbonate
Protection Degree From Water And Dust		IP65 DIN EN 60529
Shock Resistance		IK08 (EN62262).
Weight		2,1 Kg

Dimensions and Constrains

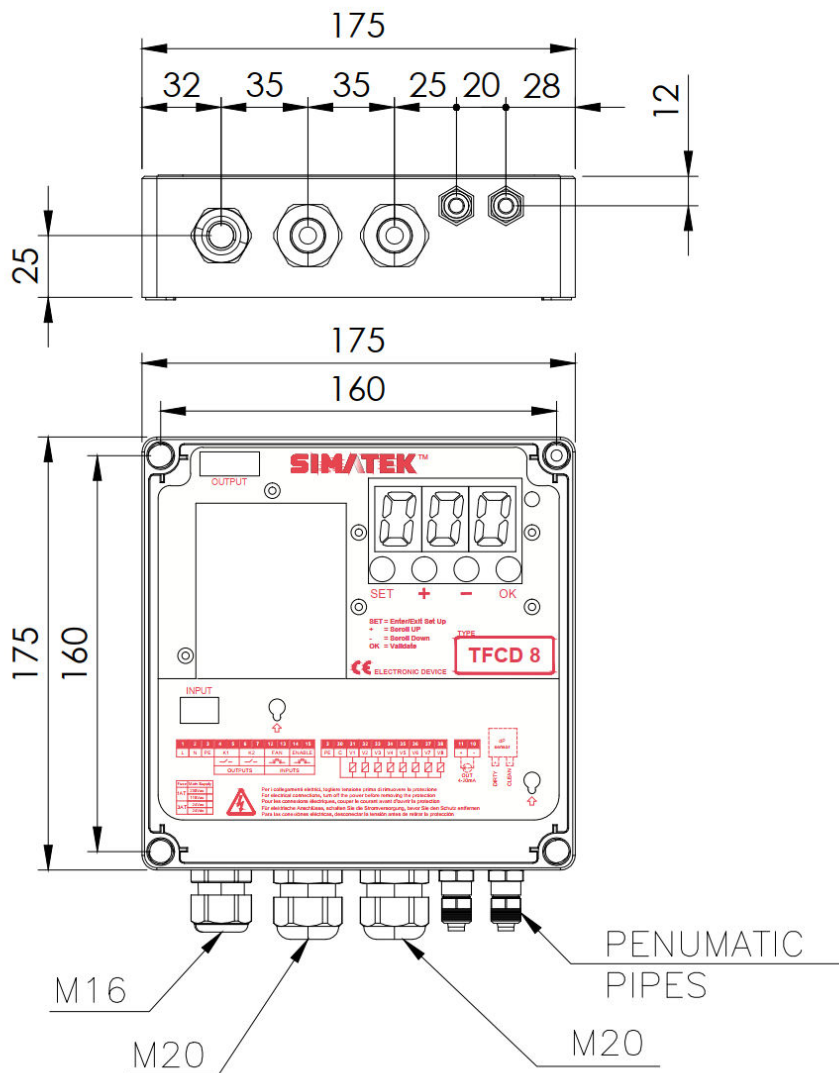

Dimensions in mm

Fastening

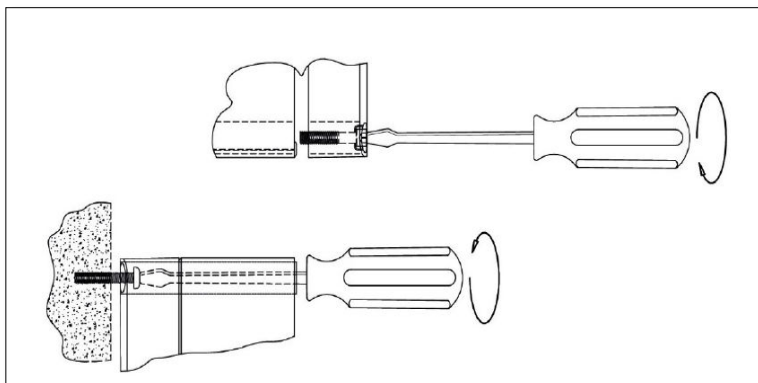



Pneumatic pipes









Warning symbols used in this manual

The safety-related indications are highlighted using the symbols:

	Attention - Danger	Warning - Generic
	Risk – Danger	Electric Current
	Dispose of in compliance with the electrical and electronic equipment Standard WEEE	

Installation regulations and warnings

<ul style="list-style-type: none"> Protect the equipment from direct exposure to sunlight. 	
<ul style="list-style-type: none"> Do not position the equipment near or directly in contact with sources of heat or electromagnetic fields. 	
<ul style="list-style-type: none"> Fix the Control Unit at a height of at least 60 cm from the ground floor and in a clearly visible place that is easily accessible. 	
<ul style="list-style-type: none"> Connect the Control Unit to a power supply line other than those used for operating motors or other high power devices, which could generate network interference or instability. 	
<ul style="list-style-type: none"> The power supply must be protected by a 230Vac 30mA Residual Current Device RCD and a bipolar 230Vac 10A magnet circuit breaker, positioned in a place that is easily accessible. 	
<ul style="list-style-type: none"> Before intervening on the equipment to perform any operation, deactivate the magnet circuit breaker switch and check if the environment conditions are safe. 	
<ul style="list-style-type: none"> For electric operations, always remove voltage, wait 30 seconds for the internal capacitors to discharge before opening. At the end of the operations, close the equipment before powering up. Before intervening on the equipment to perform any operation, check the conditions of the atmosphere are safe. 	
<ul style="list-style-type: none"> The PE (ground terminal/Earth) wire must be Yellow/Green and it must be the first to be connected. No other cables different than PE must be with its color. 	
<ul style="list-style-type: none"> The terminal block must not be the mechanical anchorage point of the wires. 	
<ul style="list-style-type: none"> Sealing of the cable glands is guaranteed by the compression of the rubber gasket that tightens on the outer diameter of the cable. 	
<ul style="list-style-type: none"> The size of cable and cable gland must ensure that power cord traction is not acting on the terminal. 	

<ul style="list-style-type: none"> Any use not described in this user instruction manual or incorrect use of the device may cause damage to the Control Unit or to the equipment connected to it. 	
<ul style="list-style-type: none"> Incorrect use or tampering with the equipment may cause injury. 	
<ul style="list-style-type: none"> The impermeability of the casing is guaranteed when the cover is closed. 	
<ul style="list-style-type: none"> Make sure that rigid or flexible ducts used for wiring, do not fill up with water or other liquids. 	
<ul style="list-style-type: none"> Switch OFF the power supply immediately if water is found in the casing. 	
<ul style="list-style-type: none"> Do not make unprotected holes in the container or holes that are protected by accessories with protection rating lower than that of the Control Unit. 	
<ul style="list-style-type: none"> If the Control Unit is used in ways not specified by the manufacturer, the protection provided by the device may be impaired. 	
<ul style="list-style-type: none"> No part with dangerous voltage is normally accessible. 	
<ul style="list-style-type: none"> The Control Unit does not release potentially toxic or harmful substances to the health and the environment. 	

	<p><u>IMPORTANT</u></p>
<p>Do not use the control unit if you have not read or do not understand this manual.</p>	

Electrical wirings

To connect the wires to the Control Unit, remove the lower front panel to access the terminal board, unscrewing the two screws.

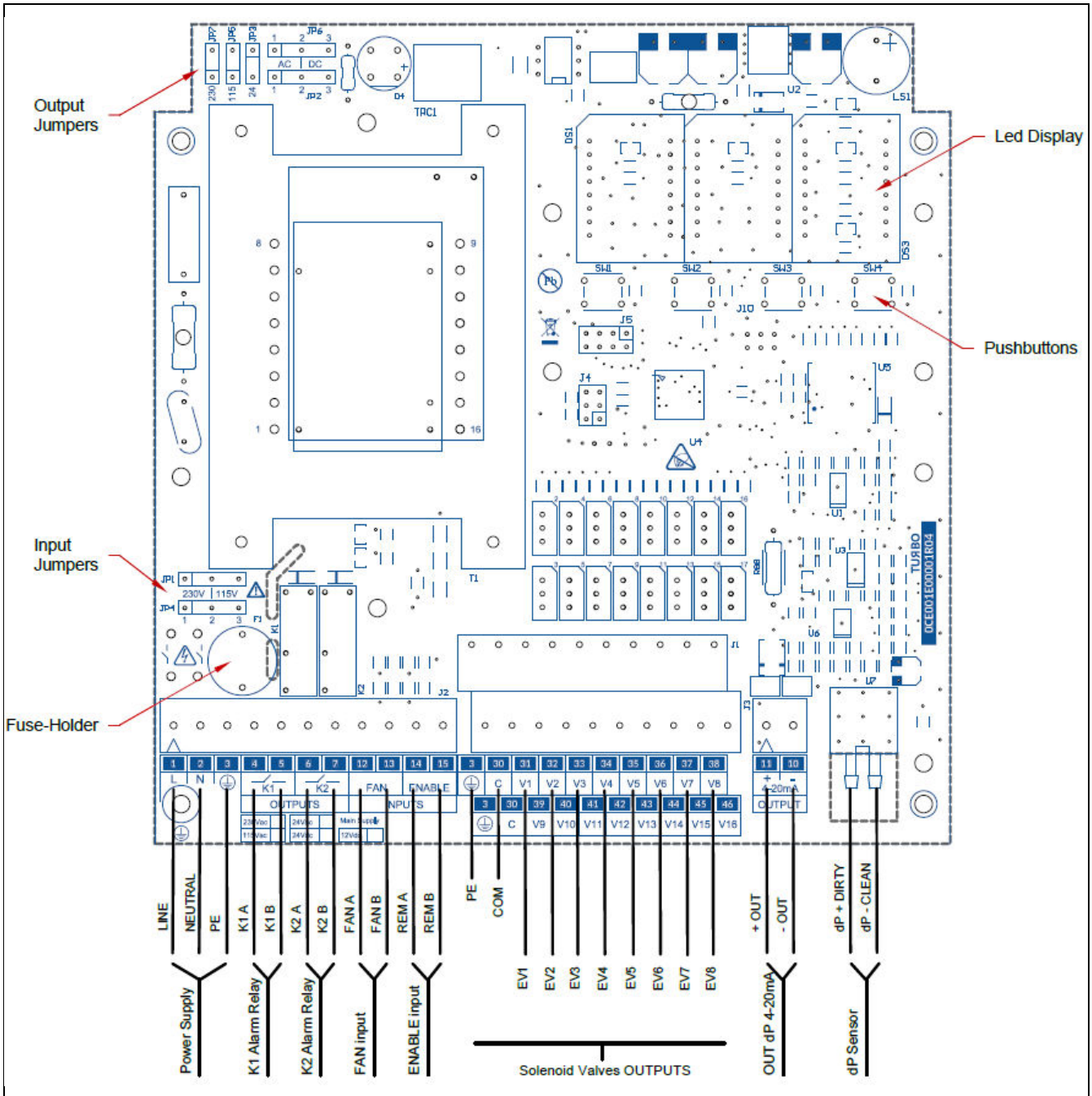

Note: If the Control Unit is a +24Vdc power-supplied model, please connect:

Terminal 1	=	+24Vdc IN
Terminal 2	=	0Vdc IN
Terminal 3	=	PE

Terminals Table

Ref.	Cat	Terminal	Marking	Description	
Main Power Supply	A	1	L	115-230Vac 50/60Hz ±10%	24Vac 50/60Hz ±10%
		2	N		24Vdc ±10%
	PE	3	PE	Protective ground terminal (Earth)	
Relay K1 Output ⁽¹⁾	B	4	1A	Contact type	1 Form A (1SPST NO)
				Ratings	250Vac/30Vdc 5A
		5	1B	Max switching voltage	400Vac
				Dielectric Strength	4000Vac (750Vac contacts)
		Expected life	10M mechanical, 100K electrical		
Relay K2 Output ⁽¹⁾	B	6	2A	Contact type	1 Form A (1SPST NO)
				Ratings	250Vac/30Vdc 5A
		7	2B	Max switching voltage	400Vac
				Dielectric Strength	4000Vac (750Vac contacts)
		Expected life	10M mechanical, 100K electrical		
Fan Status Input ⁽²⁾	C	12	FANA	Mode	Free contact (limited to 5mA@5V)
		13	FANB	Insulation	2KVac main transformer
Remote Enable Input ⁽²⁾	C	14	REMA	Mode	Free contact (limited to 5mA@5V)
		15	REMB	Insulation	2KVac main transformer
Ground	PE	3	PE	Protective ground terminal (Earth)	
Solenoid Valve Common	D	30	COM	Ratings	8A
				Max switching voltage	600VAC
Solenoid Valve Output	D			Ratings	4A
				Max switching voltage	600VAC
		31	EV1		
		32	EV2		
		33	EV3		
		34	EV4		
		35	EV5		
		36	EV6		
		37	EV7		
		38	EV8		
4-20mA Output	C	10	-OUT	Ratings	3 to 28mAdc
		11	+OUT	Self-powered Voltage	15Vdc 50mA max

Note (1): Free-voltage SPST contacts.

Note (2): Free-voltage contacts powered by the main-board. DO NOT provide voltages at these terminals.



DANGER

Risk of electric shock

The input and output terminals, numbered 12 to 15 are safety extra low voltage (SELV) terminals and must only be connected to low voltage circuits.

Recommended cable cross-section

Cat	Cable Cross-section	Approvals	Notes
A	0,75 mm ²	IEC60227, IEC60245	No-Flame or flame-retardant cable
B	0,75 mm ²	IEC60227, IEC60245	No-Flame or flame-retardant cable
C	0,50 mm ²	IEC60227, IEC60245	No-Flame or flame-retardant cable
D	0,75 mm ²	IEC60227, IEC60245	No-Flame or flame-retardant cable
PE	0,75 mm ²	IEC60227, IEC60245	No-Flame or flame-retardant cable, Yellow/Green cable

Fuse Table & replacing

Voltage	Value
230 Vac	1AT 250V
115 Vac	1AT 250V
24Vac/dc	3AT 60V/250V



DANGER

Risk of electric shock

Before replacing the main Fuse on the board, you **MUST** remove the main power supply to avoid electrical shocks.

To replace the fuse:

- Remove the lower front panel;
- Unscrew the black fuse-holder cap;
- Remove the fuse cap with the fuse inside;
- Replace the fuse with a new one;
- Insert the fuse in the fuse cap;
- Insert the fuse cap into the fuse-holder;
- Screw the fuse-holder cap;
- Close the lower front panel;
- Power-on the Control Unit.

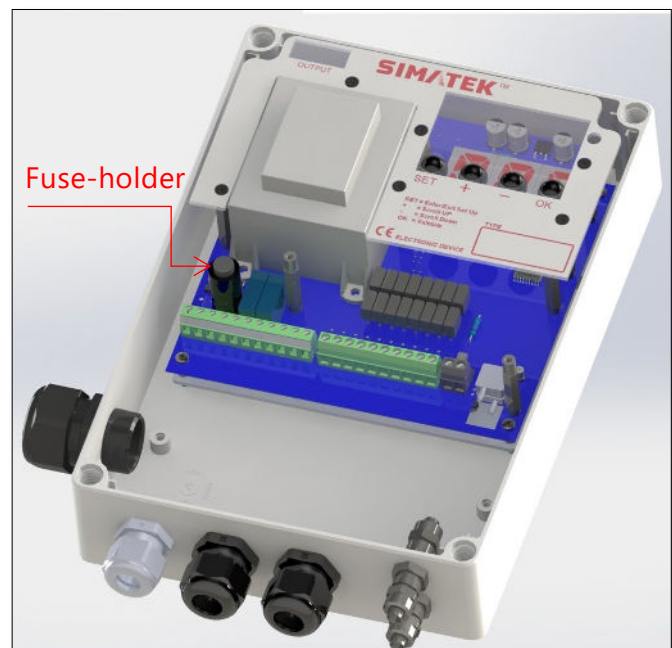

Jumper Configuration for Power Supply Input

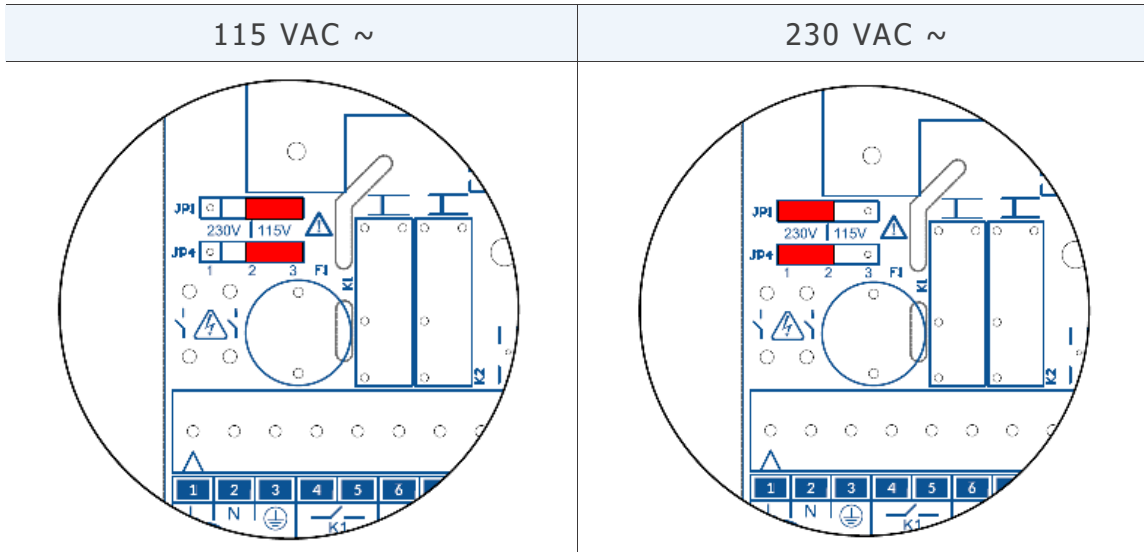

In the 24Vac and 24Vdc models JP1 and JP4 jumper are not used.

Jumper Configuration for Output Voltage

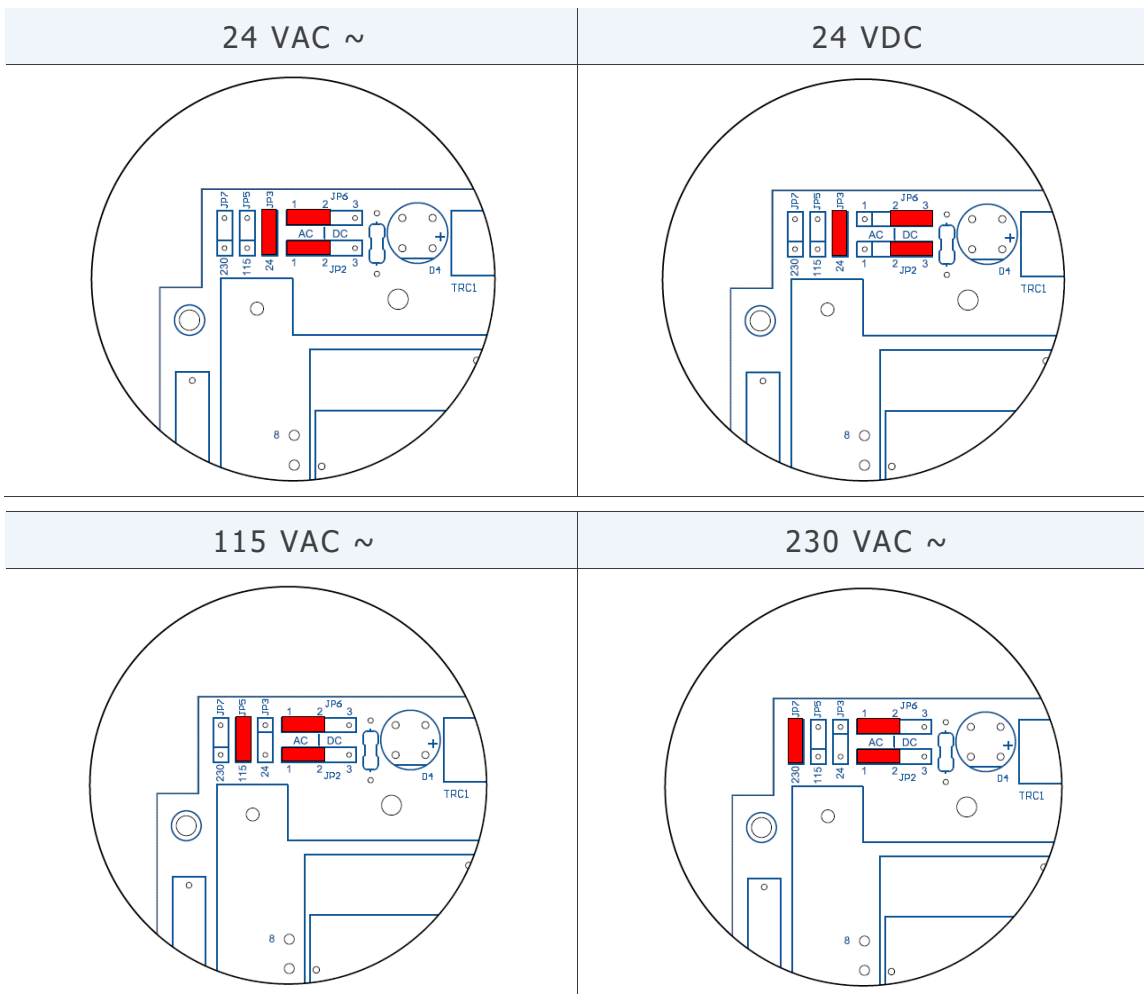

The output voltages 115Vac or 230Vac is not available in 24VAC or 24VDC power input models,

Display and pushbuttons

A local user interface made of a large seven segment display and four pushbuttons is available on the Control Unit. The user interface shows the main functionalities and events during a cleaning process.

It is also useful to access to the programming parameters.

At power-on the Control Unit will show the software version mounted for few seconds and then it will be ready to be used.

In economizer models, the dP pressure is the main information shown on display. It will be alternated with some other information like time countdown, output pulsed and error codes.

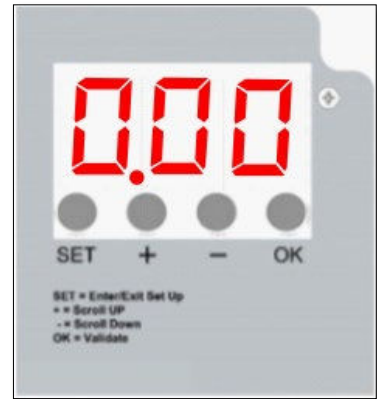

The pushbuttons enable the user to perform some operations:

(SET)	Enable the user to access or exit the programming mode.
	Activate a single solenoid during manual test with the related function F06, available in programming mode.
(OK)	Save parameter's value modified during programming mode.
	Reset alarms in main screen.
(+)	Increases the scroll of the parameters in programming mode.
	Increases the value of a selected parameter during programming.
	Displays the total hours counter since the first power-on.
(-)	Decreases the scroll of the parameters in programming mode.
	Decreases the value of a selected parameter during programming.
	Displays the partial hours counter for maintenance.

Accessing the programming menu

Press (SET) pushbutton to access the programming mode. The blinking message "F01" will appear to indicate the first parameter available.

Press (+) or (-) pushbuttons to move at the required parameter.

Press (OK) pushbutton to access the value of the selected parameter.

Press (+) or (-) pushbuttons to change the value of the parameter.

Press (OK) to save the parameter's value.

Press (SET) pushbutton to exit the programming menu and return to the main screen.



List of Parameters

Function		Min Value	Max Value	default Value
F01 Operation mode:	0=MANUAL MODE (*) 1=AUTO MODE 2=AUTO FORCED 3=PROPORTIONAL (*) dP feature disabled	0	3	1
<u>Note:</u> when F01=0, change F11 to 0 in order to recognize the fan OFF by mean of contact input at 12-13;				
F02 Solenoid activation Time (seconds)		0,05	5,00	0,20
F03 Pause Time between solenoids activations (seconds)		001 010 (F01=3)	999	20
F04 Number of solenoids connected		01	08	01
F05 Output voltage setting (related to hardware jumpers)	D24= Out 24Vdc A24= Out 24Vac 115= Out 115Vac 230= Out 230Vac	d24	230	A24
F06 Manual Solenoid valve activation for test		1	F04	1
F07 Zero dP offset		0,00 KPa	9,99 KPa	0,00 KPa
F08 Cleaning cycle dP START threshold		0,00 KPa (F09)	9,99 KPa	0,80 KPa
F09 Cleaning cycle dP STOP threshold		0,00 KPa (F12)	9,99 KPa (F08)	0,40 KPa
F10 Maximum dP value (E09)		0,00 KPa	9,25 KPa	3,00 KPa
F11 Fan OFF detection mode for Post Cleaning function	0= by input contact 1= by dP	0	1	1
<u>Note:</u> Set value=0 if F01=0 (to disable dP in MANUAL MODE)				
F12 dP threshold value for Fan OFF detection (if F11=1)		0,00 KPa	9,99 KPa (F09)	0,10 KPa
F13 Amount of Post Cleaning cycles after Fan stop		0	99	1

Continue...

Function		Min Value	Max Value	default Value
F14 Pause Time between solenoids valve activation when in Post Cleaning cycle (seconds)		1	999	10
F15 Maintenance Time limit for warning (E11) expressed in 10th of hours		1	999	100
F16 Maintenance Time limit warning (E11)	0=Disabled 1=Enabled	0	1	0
F17 Maintenance Hour counter Reset	0=No Reset 1=Reset Counter	0	1	0
<u>Note:</u> if F17 was set to 1, it automatically set back to 0 after counter reset				
F18 Precoating function	0=Disabled 1=Enabled	0	1	0
F19 Precoating dP threshold		0,00 KPa	9,99 KPa	2,00 KPa
F20 Minimum dP detection and alarm (E13)	0=Disabled 1=Enabled	0	1	0
<u>Note:</u> E13 Validation time = 60 seconds				
F21 Minimum dP threshold value (broken sleeve/cartridge)		0,00 KPa (F12)	9,99 KPa	0,20 KPa
F22 Time scale for AUTO FORCED	0=minutes 1=Hours	0	1	0
F23 Time interval for AUTO FORCED (respect to F22)		1	999	240
F24 Exclusion of a solenoid in case of short circuit	0=Leave the solenoid 1=Skip the solenoid	0	1	0

Notes:

Description of the operations

After showing the software version at power-on, the Control Unit shows the message “---”, meaning that a diagnostic task is running to check the coherence between settings stored in the microcontroller memory and the hardware jumpers settings.

An error code will appear in case of discrepancies between settings (see Alarms list). Only editing functions will be allowed on the Control Unit. The operator may switch-off the device, check and configure the hardware jumpers in the right manner.

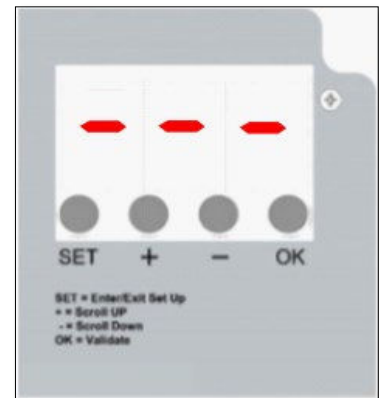

At the end of the diagnostic task, a “0_0” message will appear on the display to indicate that the test was successfully completed.

The dP value read by the on-board differential pressure sensor will appear on the main screen.

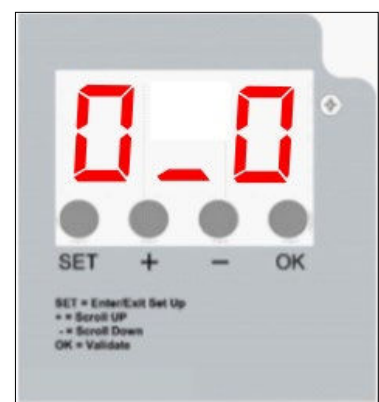

A “OFF” message appears if the “Remote EN” contact input (terminals 14-15) is open.

The message will be alternated with dP value read.

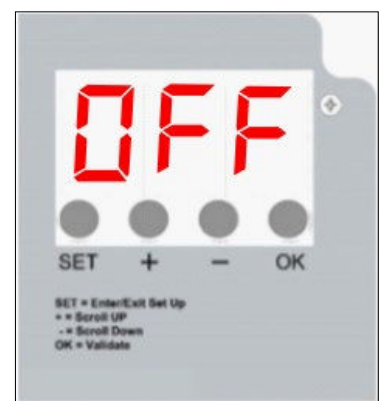

A “-0-” message appears if the “FAN Status” contact input (terminals 12-13) is open when the Control Unit is in Manual mode.

The message will be alternated with dP value read.

The same message will appear when the Control Unit is in AUTOMATIC mode also if the dP value read is lower than the value set in F12 parameter.

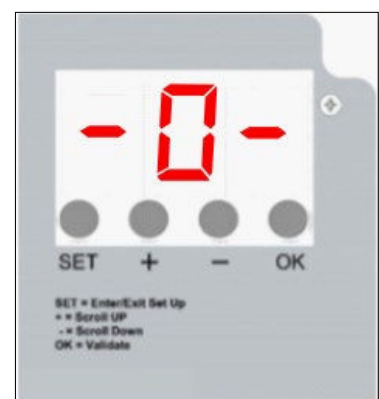

Operating Modes

MANUAL Mode

The Control Unit works as a programmable cycle sequencer.

The solenoids connected at the control unit will be activated sequentially in order to perform a cleaning cycle, with the timing values configured in the related parameters. After the last activated solenoid valve, the cleaning cycle will continue restarting from the first solenoid valve

Parameters involved:

F01	0 (MANUAL)
F02	Pulse Time
F03	Pause Time

AUTOMATIC Mode

The Control Unit works autonomously, performing the cleaning cycle only when necessary. The cleaning cycle starts when the differential pressure read by the on-board sensor exceeds the "dP START threshold" value configured in the parameters.

If the read dP pressure falls under the "dP STOP threshold" configured in the parameters, the cleaning cycle will be stopped.

It will start again when the pressure will exceed the "dP START threshold".

If the pressure read remains greater than the "dP STOP threshold" value at the end of the last solenoid's valve activation, the cycle will continue starting again from the first solenoid valve.

Parameters involved:

F01	1 (AUTOMATIC)
F02	Pulse Time
F03	Pause Time
F08	dP START threshold
F09	dP STOP threshold

AUTOMATIC Mode with FORCED Cycle

The Control Unit works in a way similar to the AUTOMATIC mode, performing an automatic cleaning cycles when required by settings OR performing a single cleaning cycle each few minutes or hours, depending on the time base set in the parameters.

The purpose of this operating mode is to ensure that at least once every scheduled period, a cleaning cycle will always be performed, even if an automatic cleaning cycle was never started.

Case 1: no conditions to start an automatic cycle

The Control Unit is placed in stand-by. When the Time interval for AUTO FORCED (minutes or hours, depending on the settings) is elapsed, it will perform one single cleaning cycle. After that, the Control Unit will return in stand-by and it will repeat one single cleaning cycle after another AUTO FORCED Time interval is elapsed. This job will continue indefinitely, observing the time interval between singles cleaning cycles.

Case 2: conditions to start an automatic cycle

If during AUTO FORCED Time interval counting, the dP pressure value read exceeds the "dP START threshold", the Control Unit will start an automatic cleaning cycle. The cycle will stop only when the dP pressure read will fall under the "dP STOP threshold". So, a new AUTO FORCED Time interval counting will be started.

Parameters involved:

F01	2 (FORCED)
F02	Pulse Time
F03	Pause Time
F08	dP START threshold
F09	dP STOP threshold
F22	Forced cycle in min/hours
F23	Time interval for Forced cycle

PROPORTIONAL Mode

In Proportional operating mode, the Control Unit works in a way similar to the AUTOMATIC mode, starting the cleaning cycle when the dP pressure read exceeds the “dP START threshold”.

The purpose of this function is to increase the speed of the cleaning cycle if a previous cleaning was not efficient as expected. It is possible to set a percentage of the efficiency with regard to the read dP.

If the read dP pressure is lower than this percentage, it means that the filter has been not sufficiently cleaned and it is necessary to increase the frequency of the cleaning.

If, at the end of a solenoid valve pulse, the read dP pressure has decreased by more than the “dP START” percentage compared to the value of previous read dP value, the cleaning cycle is stopped and then restarts at next exceeding same value.

If the pressure does not fall below the “dP START” percentage compared to the value of previous dP value read at the end of a solenoid valve pulse during the cleaning cycle, the Control Unit will reduce proportionally the Pause Time each pulsing until reaching a minimum time set in parameters. This limit has been set in order to avoid a critical condition for the air supply system (compressor) connected to the cleaning filter.

The PROPORTIONAL mode takes the highest priority respect to the “AUTOMATIC” mode. This means that the Proportional mode parameters and calculated values could exclude some parameters set for “AUTOMATIC” mode.

The “PROPORTIONAL” mode will terminate the cleaning cycle only when the dP pressure read will go under the percentage of the “dP START threshold” with regard to the last read dP pressure, bypassing the “dP STOP threshold” if that has a greater value than the with percentage calculated one.

Parameters involved:

F01	3 (PROPORTIONAL)
F02	Pulse Time
F03	Pause Time
F08	dP START threshold
F09	dP STOP threshold
F61	% dP for STOP
F62	% decr. Pause Time
F63	Minimum Pause Time

Other functions

POST CLEANING CYCLE (PCC)

This function allows to perform a cleaning cycle after the fan was stopped (OFF state) by the user.

The PCC function is enabled if the value configured in "PCC cleaning cycles" was set with a value different from zero. This parameter determines how many PCC cycles will be performed.

If "Fan detection mode" parameter is set to 0, the PCC function will be performed only if the Fan Status Input contact (terminals 12-13) will be opened.

If "Fan detection mode" parameter is set to 1, the PCC function will be performed if the read dP pressure falls under "dP Fan OFF" value.

The PCC Pause Time is available to be set in order to perform a different Pause Time than in standard cleaning cycle. The Pulse Time (F02) is the same previously set for a standard cleaning cycle.

PCC handled by "FAN OFF" input contact

The number of the PCC to perform can be set with "PCC cleaning cycles" parameter. At the end of the last PCC, the Control Unit will stop all activities until the Fan Status Input contact will be detected as closed. Then, a new standard cleaning can start, if required.

If the Fan Input Contact is detected as closed while a PCC is in progress, a new standard cleaning cycle will be started at the end of PCC, if required.

PCC handled by "FAN OFF" dP threshold

The PCC will be performed if the dP pressure read goes under the "dP Fan OFF" value and if at least one time from the power-on the dP pressure read has exceeded the "Fan OFF" value.

At the end of a PCC, the Control Unit will wait again to exceed the "dP START threshold" value to perform a new cleaning cycle.

Only PCC cleaning cycle

It is possible to set "Enable cleaning cycle" parameter to zero in order to perform only PCC function, disabling all the other cleaning modes. In this way the only cleaning cycle available will be a PCC and it will be performed only if the FAN OFF state will be recognized by contact or dP event.

Parameters involved:

F11	Fan detection Mode
F12	dP FAN OFF
F13	PCC cleaning cycles
F14	PCC Pause Time
F53	Cycle END mode
F64	Enable cleaning cycle

PRE-COATING (PC)

This function allows to activate a precoating function, a specific treatment of the filter elements that is performed with a material suitable for the purpose, called "precoating powder".

If pre-coating is enabled, the control unit will read the dP pressure value and wait until that value exceeds the pre-coating threshold before to enable and perform a standard cleaning cycle in both MANUAL or AUTOMATIC modes.

After the standard cleaning cycle is started, the pre-coating function will be automatically disabled.

No cleaning cycle will be performed until the programmed threshold doesn't exceeds during precoating function.

dP OFFSET ADJUSTMENT

This function allows to adjust the offset of the dP reading during the FAN OFF.

It is possible to increase or decrease the value of the parameter using (+) and (-) pushbuttons when in programming mode.

Press (OK) pushbutton to save the value into the microcontroller memory. This value will be subtracted from the value read by the on-board pressure sensor.

dP SELF-CALIBRATION

This function allows to perform a dP reading self-calibration task.

Place the Control Unit in power-off and remove pneumatic pipes. Press and hold (SET) and (OK) pushbuttons together. Then supply power again by keeping the pushbuttons pressed until the message "CAL" will appear.

Release the pushbuttons. The automatic task will perform self-calibration and then return to its normal functioning.

Number of solenoids connected

The amount of solenoids valves connected at the Control Unit can be set. The Control Unit will run the cleaning cycle in order from the first to the last solenoid valve programmed into the parameter.

Parameters involved:

F01	Operating mode
F02	Pulse Time
F03	Pause Time
F18	Pre-coating enable
F19	Pre-coating dP thresh

Parameters involved:

F07	Zero dP Offset
-----	----------------

Parameters involved:

F04	Number of solenoids
-----	---------------------

Hour Counters

After showing the software version at power-on, the Control Unit

An hour counters information is available on the main screen.

The purpose is to show the total operating hours from the first power-on and the maintenance hours.

By pressing the (+) pushbutton the display will show the operating hours from the first power-on. The value can't be reset.

By pressing the (-) pushbutton the display will show the maintenance hours. The parameter F17 can be used to reset the maintenance hours.

The hours are shown on two screen.

The first screen shows the thousands of hours, the second screen shows the units of hours.

Example:

First screen count = 012

Second screen count = 345

Amount of hours = $(012 \times 1000) + 345 = 12345$



Inputs & Outputs

Inputs	Terminals	Description
Remote ENABLE contact	14-15	<p>It is used to place the Control Unit in Run or Stand-By mode.</p> <p>When the input contact is open, the Control Unit is placed in stand-By mode. No functions will be executed.</p> <p>When the input contact is closed, the Control Unit is placed in Run mode. All the functions will be executed when needed.</p> <p>The Control Unit is factory set with a wire jumper between the terminals to close the input.</p>
FAN Status contact	12-13	<p>It is used to send to the control unit the state of the fan (Running or Stopped).</p> <p>If the input contact is open, the control unit will detect the fan stopped and then run the Post Cleaning function.</p> <p>The control unit is factory set with a wire jumper between the terminals to close the input.</p>

Outputs	Terminals	Description
Alarm Relay K1	4-5	<p>The relay K1 is factory configured as normally closed contact and opens with multiple error events.</p> <p>The contact is also open when the control unit is not powered.</p> <p>The alarms events set by default for the relay are: Max dP Min dP E06 E08. Maintenance interval reached.</p>
Alarm Relay K2	6-7	<p>The relay is factory configured as normally closed contact and opens when dP Max error event is detected.</p> <p>The contact is also open when the control unit is not powered.</p> <p>The alarms events set by default for the relay are: Max dP</p>
dP Output (4÷20mA Current-Loop)	11-10	<p>Self-powered (active) current-Loop output. It is used to transmit dP pressure value measured to a remote reader or to a control room.</p>

Hidden Parameters

An "Hidden Parameters" menu is available on the Control Unit. With this, the expert technician can configure additional functions.

MAIN FUNCTIONS OF THE HIDDEN MENU

- Set the event to associate to Alarm Relay contact;
- Set the state of the Relay contact during alarm;
- Reset the main Hour counter;
- Set the Cycle End mode;
- Set the measure unit;
- Set the parameters for Proportional mode;
- Enable/disable the dP alarms;
- Calibrate the current-loop output;
- Set the Full-scale for current-loop output;
- Set the state of the digital inputs;
- Enable and set a delay time at power-on;
- Set Pulse Time and/or Pause Time to work in seconds or minutes;
- Reset all parameters to factory default;

HOW TO ACCESS THE HIDDEN MENU

In main screen, press (SET) and (OK) pushbuttons together for at least 2 seconds until the message "--" appears on the display.

Press (-) pushbutton. The message " - -" appears on the display.

Press (OK) pushbutton. The message " -" appears on the display.

Press (+) pushbutton. The message "F50" appears on the display to confirm the access to the Hidden Menu.

In Hidden Menu:

Press (+) or (-) pushbuttons to move at the required parameter.

Press (OK) pushbutton to access the value of the selected parameter.

Press (+) or (-) pushbuttons to change the value of the parameter.

Press (OK) to save the parameter's value.

Press (SET) pushbutton to exit the programming menu and return to the main screen.

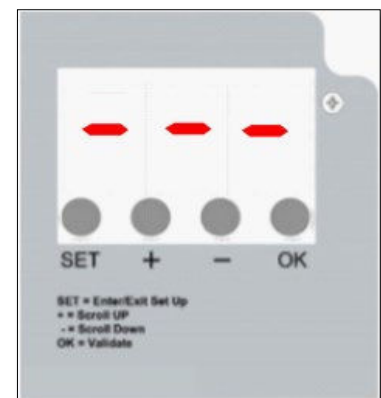

List of Hidden Parameters

Function		Min Value	Max Value	default Value
F50 Relay contact during alarm	0= OPEN with AUTORESET 1= OPEN with MEMORY 2= CLOSED with AUTORESET 3= CLOSED with MEMORY	0	3	0
Note: AUTORESET = the relay contact will automatically return to its rest state if alarm event disappears. MEMORY = the relay contact will return to its rest state only if the user will press (OK) pushbutton to reset the error.				
F51 Solenoid Presence and Overload	0= Disable control 1= Only Overload (E07) handled 2= Only Presence (E06) handled 3= Both Overload and Presence (E06+E07)	0	3	2
F52 Overload sensitivity (used with F51 =1 or 3)		0	9	5
F53 End mode for cleaning cycle	0= STOP at the END of the cycle 1= IMMEDIATE STOP	0	1	1
F54 Main Hour Counter Reset	0= Doesn't take effect 1= Reset main hour counter	0	1	0
<u>Note:</u> After RESET, the parameter's value automatically returns to zero.				
F55 Automatic detection Of solenoids	0= Disabled 1= Enabled	0	1	0
F56 Hardware Offset for dP Pressure sensor		0,00KPa	4,25KPa	1,00KPa
<u>Note:</u> The value is stored during factory test. Do not modify !				
F57 Odd solenoids in G2 models		0	1	0
<u>Note:</u> Available only in models assembled for G2 option				

Continue...

Function		Min Value	Max Value	default Value
F58 Event to associate to Relay K1	0= Cumulative error ⁽¹⁾ 1= Maximum dP (E09, E12) 2= Minimum dP (E13) 3= Solenoid Error (E06, E07, E08) 4= Maintenance warning 5= Cleaning cycle running 6= Control Unit powered ⁽²⁾	0	6	0
<p><u>Note</u>⁽¹⁾: Cumulative error is intended as one between E06 to E13 errors. <u>Note</u>⁽²⁾: Active closed. F50 doesn't take effect.</p>				
F59 Event to associate to Relay K2	0= Cumulative error ⁽¹⁾ 1= Maximum dP (E09, E12) 2= Minimum dP (E13) 3= Solenoid error (E06, E07, E08) 4= Maintenance warning 5= Cleaning cycle running 6= Control Unit powered ⁽²⁾	0	6	1
<p><u>Note</u>⁽¹⁾: Cumulative error is intended as one between E06 to E13 errors. <u>Note</u>⁽²⁾: Active closed. F50 doesn't take effect.</p>				
F60 dP Measure unit	0= KPa 1= Inch WC 2= mmH2O 3= daPa	0	3	0
F61 Percentage of dP START to STOP cycle in Proportional mode		1%	99%	15%
F62 Percentage to decrease Pause Time in Proportional mode		1%	99%	10%
F63 Minimum Pause Time in Proportional mode (seconds)		10	(F03)	10
F64 Cleaning cycle	0= Only PCC cycle 1= All cleaning cycles enabled	0	1	1
F65 Jumpers test	0= Test disabled 1= Test enabled	0	1	1
<u>Note</u> : When disabled, the value of F51 is forced to zero				
F66 Shorted Output Test	0= Test disabled 1= Test enabled	0	1	1

Continue...

Function		Min Value	Max Value	default Value
F67 dP Alarms (E09, E12)	0= Alarms disabled 1= Alarms enabled	0	1	1
F68 dP Output scale	0= 20mA@1KPa 1= 20mA@3KPa 2= 20mA@5KPa 3= 20mA@7KPa 4= 20mA@10KPa	0	4	4
F69 4mA calibration for dP output		0	500	250
Note1: The value is stored during factory test. Do not modify ! Note2: The control Unit will force 4mA at the output to help calibration.				
F70 20mA calibration for dP output		0	500	250
Note1: The value is stored during factory test. Do not modify ! Note2: The control Unit will force 20mA at the output to help calibration.				
F71 Delay Time before running PCC (seconds)		0	240	60
Note: The function is available with OPTION 1 activated, on request.				
F72 Digital Inputs setting	0= Both active closed 1= FAN STATUS active open 2= REMOTE ENABLE active open 3= Both FAN and REMOTE active open	0	3	0
F73 Unit for Pause Time	0= Seconds 1= minutes	0	1	0
F74 Delay at power-on	0= Disabled 1= Enabled	0	1	0
F75 Delay Time at power-on (minutes)		0	16	5
Note: used if the function is enabled by F74. Countdown in seconds.				
F76 Unit for Pulse Time	0= Seconds 1= x60 seconds (minutes) 2= x10 seconds	0	2	0
F77 Reset Parameters values to factory default	0= Disabled 1= Enabled	0	1	0
Note: After Reset task, the value of the parameter will automatically return to zero.				

Main functions of the Hidden menu

RELAY for event signalling

Each of the available relays can be configured to signal a well-defined event between those available.

The F50 parameter establishes how the relay contacts works during an event to handle. The parameter affect both the relay contacts at the same time and it is not possible to have a different contact setting for each relay.

If F50 is set to "0" or "2" and the related alarm event disappears, the relay will automatically return to its rest state.

If the alarm event is related to solenoids, the error will be automatically removed if the next pulse on that solenoid will be OK.

The "Control Unit powered" event is not affected by F50. When the Control Unit is powered and F58 or F59 is set to 6, the relay contact will be always closed.

Solenoids Fault Events

The F51 and F52 parameters handles the error events related to solenoids. It is possible to introduce or exclude the detection of alarms concerning the missing connection of a solenoid or its overload.

It is also possible to establish the sensitivity for the overload.

End mode for cleaning cycle

The F53 parameter handles the end of a cleaning cycle. It is usually used when the Control Unit is configured to work in AUTOMATIC modes.

When F53=1, if the dP pressure read falls below the "Cleaning cycle dP STOP threshold" (F09), the cleaning cycle will be immediately stopped.

When F53=0, if the dP pressure read falls below the "Cleaning cycle dP STOP threshold" (F09), the cleaning cycle will continue until the last solenoid have pulsed and its Pause Time will be elapsed.

Set the Measure Unit

The F60 parameter set the measure unit of the dP pressure read by the on-board pressure sensor. By changing the measure unit, all the parameter values relating to the dP thresholds will be recalculated and will change automatically in microcontroller memory.

Parameters involved:

F50	Relay contact during alarm
F58	Event to associate to Relay K1
F59	Event to associate to Relay K2

F51	Solenoid Presence and Overload
F52	Overload sensitivity

F53	End mode for cleaning cycle
-----	-----------------------------

F60	dP Measure unit
-----	-----------------

dP Alarms

The F67 parameter enables the handling of the alarms related to the dP minimum and maximum. Disabling the parameter, no error related to the dP will be handled and displayed.

F67	dP Alarms
-----	-----------

State of the digital inputs

The F72 parameter handles the logic of the detection of the digital inputs. It is possible to set the logic state of each digital inputs in order to refine the detection with the expected signal coming from an external switch, PLC or DCS device.

F72	Digital Inputs setting
-----	------------------------

Delay Time at power-on

It is possible to delay the start of control Unit functions by setting F74 and F75 parameters. The setting will take effect from the next power-on. The display will show an activation countdown expressed in seconds.

F74	Delay at power-on
F75	Delay Time at power-on

Pulse and Pause Time unit

The F73 and F76 parameters allow to change the time unit for the Pulse Time and the Pause Time. It is possible to set time unit in seconds or minutes.

F73	Unit for Pause Time
F76	Unit for Pulse Time

Delay Time before running PCC

This feature is available only on request (OPT1). It allows to introduce a delay time in seconds between the end of a cleaning cycle and the starting of a PCC. Without this option, the Control Unit will start a PCC immediately at the end of a cleaning cycle, if required and programmed.

F71	Delay Time before running PCC
-----	-------------------------------

Reset parameters to default values

The F77 parameter allows to restore all parameters to the factory default values, with the exception of those relating to electrical and pneumatic calibrations.

F77	Reset Parameters values to factory default
-----	--

Alarms

The control Unit perform some diagnostic check at power-on and during operations.

An alarm event is shown by mean of "Exx" error code. The possible alarms and respective troubleshooting are listed in the below table:

Alarm Event	Description	Action
E01	F05 set to 24Vdc but AC jumper position detected	For 24Vdc, switch the device off and set the AC/DC jumpers to DC. For 24Vac, press OK, then press SET, set the function F05 using (+) and (-), select A24 and press OK to confirm.
E02	F05 set to 24Vac but DC jumper detected	For 24Vac, switch the device off and move the AC/DC jumpers to AC. For 24Vdc, press OK, then press SET, set the function F05 using (+) and (-), select d24 and press OK to confirm.
E03	F05 set to 24Vac or 24Vdc. Voltage Out of Range detected	To use 24V valves, switch the device off and move the output voltage selection jumper to 24V. - If the jumper is in the correct position, press OK, then SET, select the F05 function with (+) and (-), set 115 or 230 (as jumper) and press OK.
E04	F05 set to 115V. Voltage Out of Range detected	To use 115V valves, switch the device off and move the output voltage selection jumper to 115V. - If the jumper is in the correct position, press OK, then SET, select the F05 function with (+) and (-), set 115 or 230 (as jumper) and press OK.
E05	F05 set to 230V. Voltage Out of Range detected	To use 230V valves, switch the device off and move the output voltage selection jumper to 230V. If the jumper is in the correct position, press OK, then SET, select the F05 function with (+) and (-), set a24, d24 or 115 (as jumper) and press OK.
E06	Solenoid valve current lower than minimum threshold or disconnected solenoid valve. The error is displayed alternating with solenoid position Uxx failed.	Check correct connection of the solenoid valve and respective data. The alarm is auto-reset if event disappears.
E07	Solenoid valve current higher than maximum threshold. The error is displayed alternating with solenoid position Uxx failed.	Check correct connection of the solenoid valve and respective data. The alarm is auto-reset if event disappears.
E08	Short circuit alarm at output. The error is displayed alternating with solenoid position Uxx failed.	Switch the device off and back on after having checked the solenoid valve system.
E09	dP maximum pressure exceeded (F10) detected for longer than 20 seconds.	Check state of filtering elements.
E10	dP sensor hardware offset Out of Range.	The self-calibration of the dP sensor has determined that a value is out of range. Disconnect the air tubes and repeat the function. Take the device to be serviced if the alarm occurs again.
E11	Maintenance deadline reached	Carry out maintenance and then reset the error.
E12	dP sensor full-scale value reached Immediate reporting without any delay	Check state of filtering elements. WARNING: Running in this condition may damage the device.

Alarm Event	Description	Action
E13	Minimum dP alarm value ranging from F12 to F21 (warning: the alarm is generated with a fixed delay of 60 seconds).	Check the status of the filtering elements.
E14	Indicates that a valve in short circuit has been excluded from the cycle. The error code E14 alternates with the indication of the failed output that is shown as "Uxx", where xx is the number of the output. An output is considered a short circuit if not responding for 3 following activations.	Switch the device off and back on after having checked the solenoid valve system.

Troubleshooting

Fault	Possible Cause	Solution
The display does not light up.	Fuse Blown. Power voltage missing.	Check the protection fuse on the power voltage. Check that the power voltage is provided at power supply terminals and compliant with that required for the device.
The outputs are not activated.	Output voltage. Wiring to solenoid valves.	Check that the solenoid valves output voltage is congruent with hardware jumper settings and programming. Check wiring between Control Unit and solenoid valves.
The differential pressure reading is not correct.	Obstructed pneumatic connections. Damaged pipes.	Check that the differential pressure is 0.00 kPa with the pneumatic pipes disconnected. Check if the connection pipes between device and filter are not obstructed or damaged.
The cleaning cycle doesn't run	In AUTOMATIC mode the dP read is too low than the dP START value set. Remote Enable input is open	Adjust the dP START threshold or set the Control Unit in Manual mode. Check Remote Enable input contact.
Does the device occasionally reset?		Check that there are no unfiltered voltage spikes on the power line (spot welding machines, welding machines, plasma cutters etc.). Install a common-mode line filter between the Control Unit and the power line.
Does post-cleaning start during normal cleaning?	dP FAN OFF threshold is too high	Change the PCC threshold by lowering it.
Does post-cleaning fail to start when the normal cleaning cycle ends?	dP FAN OFF threshold is too low	Check that the measured pressure is lower than the dP FAN OFF value when the fan is off.
Do the alarms fail to activate relay contacts?		The relay contacts must be powered by external voltage A relay contact opens when activated by an alarm event.
The value of 0.00 kPa does not appear on the display when the fan is off.	dP Offset is not correct	Set the dP Offset value parameter. Run a dP self-calibration task to zeroing the measure.

Maintenance

The control unit has no parts that can be replaced, except for the fuse.

All repair operations must be carried out by the manufacturer.

To clean dust and dirt from the surfaces, gently rub with cotton or other soft cloth soaked with non-aggressive, non-abrasive detergents, use those used for glass surfaces; do not use solvents or aromatic compounds and do not rub with abrasive sponges.



Disposal

Dispose of properly after use. Dispose of the product according to laws in force for electronic equipment.

This device is for use in a dust collection system and is therefore part of a fixed installation.



Warranty

The warranty has a duration of 2 years. The company will replace any electronic component deemed defective exclusively at our workshop, except in the presence of contrary agreements to be authorized by the company.

Warranty Exclusions

The warranty will be cancelled in case of:

- Signs of unauthorized tampering or repairs.
- Incorrect use of the device not respecting technical data.
- Wrong electrical connections.
- Failure to respect system standards.
- Use not in accordance with EC standards.
- Atmospheric events (lightening, electrostatic discharges,), power surges.
- Obstructed pneumatic connections. Damaged tubes.